



# AquaCal®

## Operation Manual P<sub>Wi</sub>

# HEATWAVE SUPERQUIET®



# TropiCool®

WATER CHILLER

*Firmware Version 2.xxx*

Important

Read this document before operating / installing this product

For additional product manuals and operation / installation procedures, please visit [www.AquaCal.com](http://www.AquaCal.com)

\_\_\_\_\_

MODEL / SERIAL NUMBER

LTM0930 REL D- (project rel 8.00)



# Table of Contents

---

<b>Contacting AquaCal AutoPilot, Inc.</b> .....	<b>1</b>
<b>Safety</b> .....	<b>1</b>
<b>1 - Operation</b> .....	<b>3</b>
1.1 Display Door .....	3
1.2 Wake Up Heat Pump .....	3
1.3 Using Entry Code to Access Heat Pump .....	4
1.4 Display Panel .....	4
1.5 Activate HEAT Mode, COOL Mode, AUTO Mode, or Deactivate Equipment .....	7
1.6 Set a desired temperature (setpoint) for the heat pump to activate .....	7
1.7 Using Shortcuts .....	8
1.8 Programming .....	10
1.8.a Setting Date and Time .....	10
1.8.b Setting Date and Time Format .....	11
1.8.c Selecting Celsius or Fahrenheit .....	12
1.8.d Setting Entry Code Option .....	13
1.8.e Disabling Entry Code Option .....	14
1.8.f Configuring Groups .....	15
f.1 Create a Group .....	15
f.2 Edit a Group .....	17
f.3 Delete a Group .....	18
1.8.g Configuring Schedules .....	18
g.1 Create a Schedule .....	19
g.2 Edit a Schedule .....	20
g.3 Delete a Schedule .....	21
1.8.h Schedule and Program Modes .....	23
1.9 External Equipment .....	27
1.9.a PoolSync® .....	28
1.9.b Operating Heat Pump (With an External Controller) .....	29
1.9.c Operating Heat Pump (With an External Flow Switch) .....	29
1.9.d Operating Multiple Connected Heat Pumps .....	29
<b>2 - Maintenance</b> .....	<b>30</b>
2.1 Water Chemistry .....	30
2.2 Cleaning Equipment .....	31
2.3 Clearances .....	32
2.4 Irrigation and Storm Run-Off .....	33
2.5 Water Flow Rates .....	33
2.6 Planned Maintenance .....	34
2.7 Freeze Protection .....	35
2.8 Winterizing .....	38
<b>3 - Appendix</b> .....	<b>41</b>
3.1 Adjusting Water Flow Using $\Delta T$ (Delta-T) .....	41
3.2 Available Accessories .....	43
3.3 Clearances .....	45
3.4 Configure Variable Speed Compressors (Select Units) .....	46
3.5 Identifying Model Specifications .....	48
3.6 Menu Trees .....	50

---

3.7 Initial Heating Recommendations .....	53
3.8 Initial Cooling Recommendations .....	54
3.9 Service Mode .....	54
3.10 Viewing System Information .....	55
<b>4 - Troubleshooting</b> .....	<b>56</b>
4.1 Fault Codes .....	57
4.2 Issues and Resolutions .....	62

## Contacting AquaCal AutoPilot, Inc.

For further assistance, please contact the distributor or installer of this product.

If unavailable, please contact AquaCal® for a partner in your area. To better assist you, please have the heat pump model and serial number available.

- See "Identifying Model Specifications" on page 48.

Product Information:	
Website	www.AquaCal.com
Phone	(1) 727-823-5642
Hours	8-5 pm, Eastern M-F

Service Information:	
Website	www.AquaCal.com/request-heat-pump-service/

## SAFETY

- For personal safety, and to avoid damage to equipment, follow all safety instructions displayed on the equipment and within this manual. Repair and service of heat pump must be performed by an authorized service center.
- Warranties may be voided if the equipment has been improperly installed, maintained or serviced.
- If service is deemed necessary, please contact AquaCal. See "Contacting AquaCal AutoPilot, Inc." above.

### SAFETY SIGNALS

Throughout this document, safety signals have been placed where particular attention is required.



Failure to heed the following will result in injury or death.



Failure to heed the following may result in injury or death.



Failure to heed the following may result in damage to equipment.

When installing and using your heat pump basic safety precautions must always be followed, including the following:



Failure to heed the following will result in injury or death.

- The heat pump utilizes high voltage and rotating equipment. Use caution when servicing.
- RISK OF ELECTRICAL SHOCK FROM ENERGY STORED IN CAPACITORS - MODELS EQUIPPED WITH VARIABLE FREQUENCY COMPRESSOR DRIVES STORE ELECTRICITY EVEN AFTER THE POWER HAS BEEN DEACTIVATED AT THE POWER BREAKER. **Wait for 2 minutes after the shut down of equipment before servicing.**
- Follow all National Electric Codes (NEC) and/or State and Local guidelines.

**WARNING**

Failure to heed the following may result in injury or death.

- Installation and repairs must be performed by a qualified technician.
- The heat pump contains refrigerant under pressure. Repairs to the refrigerant circuit must not be attempted by untrained and/or unqualified individuals. Service must be performed only by qualified HVAC technicians. Recover refrigerant before opening the system.
- Improper water chemistry can present a serious health hazard. To avoid possible hazards, maintain pool/spa water per standards as detailed in this document.
- Prolonged immersion in water warmer than normal body temperature may cause a condition known as Hyperthermia. The symptoms of Hyperthermia include unawareness of impending hazard, failure to perceive heat, failure to recognize the need to exit the pool or spa, and unconsciousness. The use of alcohol, drugs, or medication can greatly increase the risk of fatal Hyperthermia. People having an adverse medical history, or pregnant women should consult a physician before using a hot tub or spa. Children and the elderly should be supervised by a responsible adult.
- Prolonged immersion in water colder than normal body temperature may cause a condition known as Hypothermia. The symptoms of Hypothermia include shivering (although as hypothermia worsens, shivering stops), clumsiness or lack of coordination, slurred speech or mumbling, confusion and poor decision-making, drowsiness or low energy, lack of concern about personal welfare, progressive loss of consciousness, weak pulse and slow or shallow breathing. Persons having an adverse medical history, or pregnant women, should consult a physician before immersing in a cold body of water. Children and the elderly should be supervised by a responsible adult.
- This appliance is not to be used by persons (including children) with reduced physical, sensory, or mental capabilities, or lack of experience and knowledge, unless they have been given supervision or instruction.
- Children must be supervised and are not to play with the appliance.

**NOTICE**

Failure to heed the following may result in damage to equipment.

- Maintain proper water chemistry to avoid damage to the pump, filter, pool shell, etc.
- Water flow exceeding the maximum flow rate requires a bypass. Damage due to excessive water flow will void the warranty.

**SAVE THESE INSTRUCTIONS**

# 1 - Operation

## IN THIS SECTION:

1.1 Display Door	3
1.2 Wake Up Heat Pump	3
1.3 Using Entry Code to Access Heat Pump	4
1.4 Display Panel	4
1.5 Activate HEAT Mode, COOL Mode, AUTO Mode, or Deactivate Equipment	7
1.6 Set a desired temperature (setpoint) for the heat pump to activate	7
1.7 Using Shortcuts	8
1.8 Programming	10
1.8.a Setting Date and Time	10
1.8.b Setting Date and Time Format	11
1.8.c Selecting Celsius or Fahrenheit	12
1.8.d Setting Entry Code Option	13
1.8.e Disabling Entry Code Option	14
1.8.f Configuring Groups	15
1.8.g Configuring Schedules	18
1.8.h Schedule and Program Modes	23
1.9 External Equipment	27
1.9.a PoolSync®	28
1.9.b Operating Heat Pump (With an External Controller)	29
1.9.c Operating Heat Pump (With an External Flow Switch)	29
1.9.d Operating Multiple Connected Heat Pumps	29

## 1.1 Display Door

The display panel is located in a door compartment on the front of the heat pump. This compartment is designed to protect the display against harsh weather. It can also be padlocked for extra security.

- Press the **bottom** of the panel to open the display panel door.
- To close, push the display panel up. Then press the **bottom** of the panel in until a clicking noise is heard.

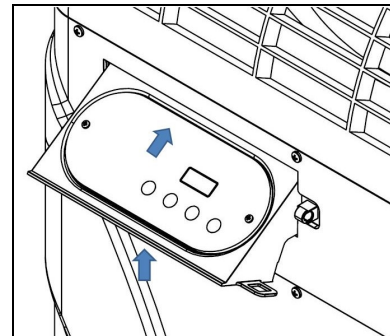
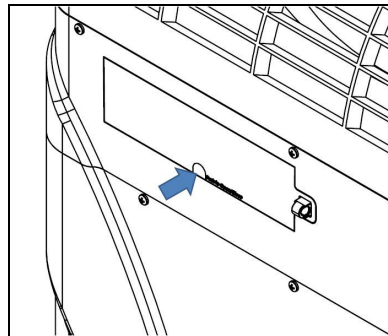

## 1.2 Wake Up Heat Pump

The display's backlight will be off when the heat pump is in sleep mode. To wake up the heat pump, slowly slide a finger across the buttons.

- The display will illuminate.
- The message "KEYPAD UNLOCKED" will briefly appear.
- Then the water temperature and mode will display.

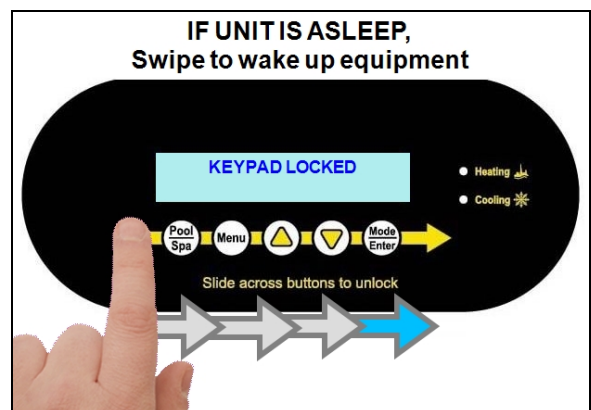

### 1.3 Using Entry Code to Access Heat Pump

If a user entry code has been enabled in the user menu, an entry code will be required to access heat pump options.

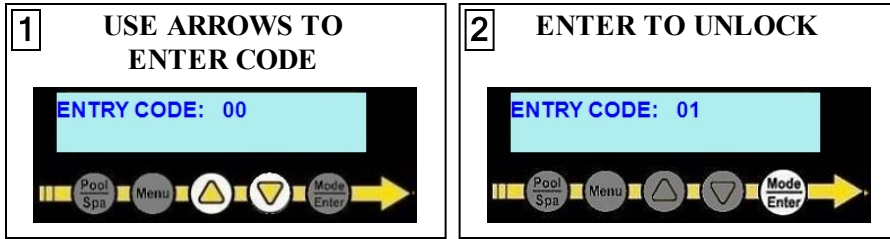

**PLEASE NOTE -**

- If the entry code has been misplaced, the heat pump will need to be reset to factory defaults.
- After three minutes of inactivity, the heat pump's sleep mode will activate. See "Wake Up Heat Pump" on the previous page.

### 1.4 Display Panel





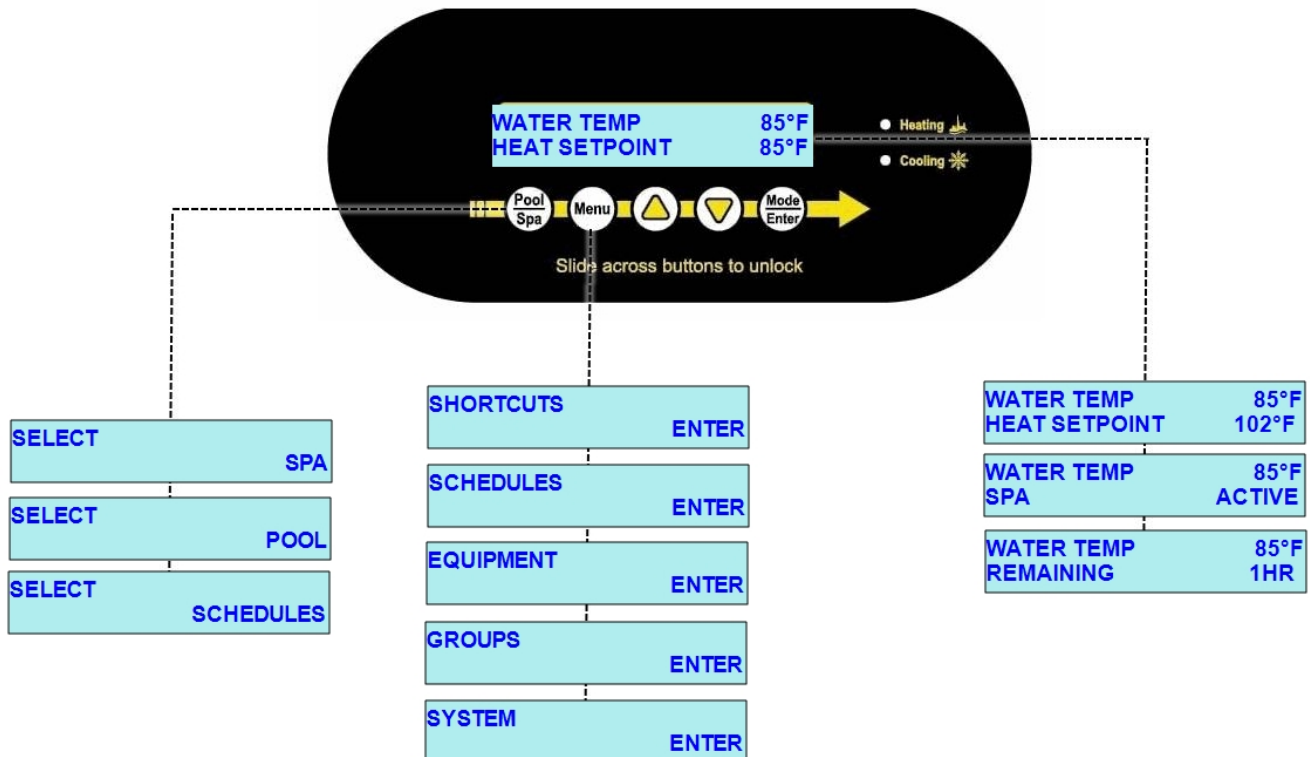

The following information outlines the operation for a standard installation.

Control Buttons will operate differently for custom installations; such as when a heat pump is connected to an external controller or multiple heat pump configuration.





## Buttons

Button	Description
	Slowly slide a finger across the buttons from left to right to disable the sleep mode. Sleep mode will automatically reactivate after three minutes have passed.
	Select either the POOL or SPA mode. Any connected valves or circulation pumps will activate. To deactivate, press the "Pool/Spa" button again until "SCHEDULES" is displayed and press the "Enter" button. If an option is highlighted, it will automatically activate after 10 seconds.
	Enter the user menus for heat pump options. Also used to exit from a menu. Press and hold the MENU button to exit to the main status screen.
	Used to increase temperature setpoint and navigate through menu options.
	Used to decrease temperature setpoint and navigate through menu options.
	Used to select the heat pump's operating mode. Also used to edit or confirm options in a menu.

## Indicator Lights

Indicator	Description
Heating	Red LED indicates the heat pump is heating the water.
Cooling	Blue LED indicates the heat pump is cooling the water.
When calling for heating or cooling, up to a three-minute delay may occur before the compressor starts.	

## Displays

	Display	Description
Entry code required	ENTRY CODE 00	The heat pump has a user lock enabled. See " <i>Using Entry Code to Access Heat Pump</i> " on page 4.
No water flow	NO POOL/SPA WATER FLOW HEAT SETPOINT 75°F	No water flow is detected. The filter pump is off or the heat pump is not receiving the correct water flow.
Primary Heat Pump	WATER TEMP 71°F PRIMARY UNIT	Primary heat pump controlling other connected heat pumps
Remote Controlled - by primary Heat Pump	WATER TEMP 71°F SECONDARY UNIT 01	Heat Pump is set to be controlled by another connected heat pump.
Remote Controlled - by external controller	WATER TEMP 75°F UNDER REMOTE CONTROL	Heat Pump is set to be controlled by an external controller.
Set to 75° F - Maintaining	WATER TEMP 70°F AUTO SETPOINT 75°F	Maintaining a water temperature set on the thermostat. In this example, the pool thermostat has been set to 75° F.
Set to 45° F - Cooling	WATER TEMP 70°F COOL SETPOINT 45°F	Cooling water to point set on the thermostat. In this example, the pool thermostat has been set to 45° F.
Set to 75° F - Heating	WATER TEMP 70°F HEAT SETPOINT 75°F	Heating water to point set on the thermostat. In this example, the pool thermostat has been set to 75° F.
Set to Off	WATER TEMP 70°F HEAT PUMP OFF	The heat pump has been deactivated using the "Mode / Enter" button. The heat pump will automatically restart on the next scheduled call for heating or cooling. Other activated devices will continue to operate

## 1.5 Activate HEAT Mode, COOL Mode, AUTO Mode, or Deactivate Equipment

Press "Mode / Enter" button until the desired mode is displayed.

- "HEAT" mode - After the fan and compressor start, the red "Heating" light will activate.
- "COOL" mode - After the fan and compressor start, the blue "Cooling" light will activate.
- "AUTO" mode - After the fan and compressor start, the heat pump will maintain the set temperature within 1°. The red "Heating" or blue "Cooling" light will activate.
- "OFF" - The heat pump will indicate it is deactivated. Any equipment connected to the heat pump will continue to operate. To deactivate all equipment connected to the heat pump, activate the service mode. See "Service Mode" on page 54.

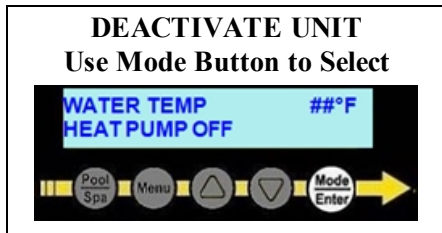
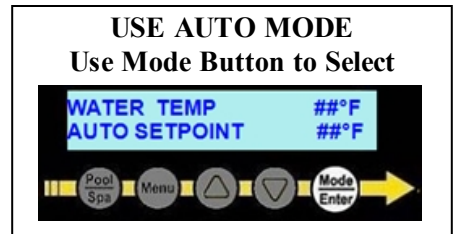
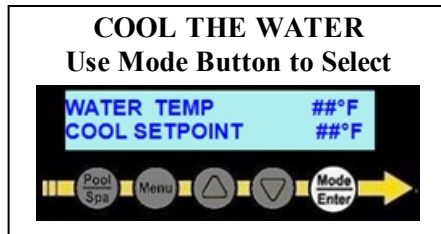
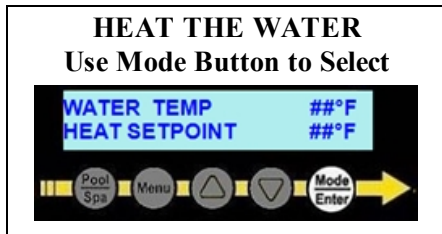

## 1.6 Set a desired temperature (setpoint) for the heat pump to activate

Press the up or down arrow to set the desired temperature (setpoint) for the water.

- The heating indicator will illuminate when heating the water.
- The cooling indicator will illuminate when cooling the water.

**PLEASE NOTE:**

The heat pump will not operate if incoming water temperatures are above 110° F (43° C). If sustained water temperatures will fall below 32° F (0° C), the equipment must be winterized in order to prevent damage. See "Winterizing" on page 38.

**NOTE:**

If a group's schedule is active and the temperature setpoint is changed, that group's temperature setpoint will also be changed.

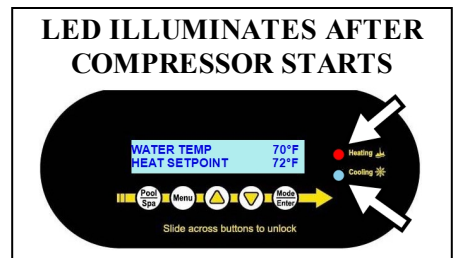
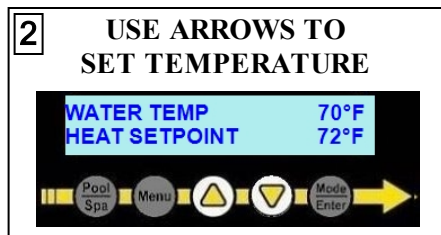
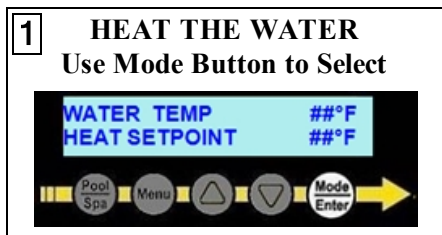

## 1.7 Using Shortcuts

The shortcuts menu provides quick access to model specific options and features. The following outlines some of these options.

### Group Access

As a group is created, a shortcut automatically appears in the shortcuts menu. The user can activate the group by shortcut and will be asked how long to operate that group.

- Multiple group shortcuts can operate at the same time. The time remaining for each group to operate will appear on the status screen.
- After the group shortcut timer expires, the heat pump group will resume its normally scheduled activity.
- To cancel the group shortcut's operation before its timer expires, go to the shortcut menu, select it, and choose "STOP".
- See "*Using a Group Shortcut*" on the facing page.
- See "*Stopping a Group Shortcut*" on the facing page.

#### **PLEASE NOTE:**

*The Spa and Pool groups (if applicable) will not appear in the shortcuts menu. Use the schedules or the Pool / Spa button to activate those groups.*

### Schedule Mode

There are three modes that can be set when running schedules.

- "AUTO" - The default mode. This allows schedules to run normally.
- "AWAY" - This mode is generally used when the user is away on vacation and doesn't want to maintain a water temperature. The heat pump will be deactivated while the rest of the schedules (including filtration) are allowed to continue.
- "OFF" - This mode turns off all schedules. The schedules resume when the schedule mode is set to "AUTO" again.
- (See "*Schedule and Program Modes*" on page 23 for more information.)

### Service Mode

This mode will deactivate the heat pump as well as all equipment connected to the heat pump.

- (See "*Service Mode*" on page 54 for more information.)

### Turbo Boost (Variable Speed Heat Pumps Only)









Upon demand, the heat pump's compressor can be set to maximum speed to heat or cool the water quickly. This is regardless of any previously set efficiency mode settings.

- The system will heat or cool the water with the compressor speed set to maximum. This will continue until the set temperature is reached. Then the configured efficiency mode (either 24-hour or scheduled) will resume.
- (See "*Configure Variable Speed Compressors (Select Units)*" on page 46 for more information.)

### Using a Group Shortcut

In this example, a user activates a group that was previously created called "FILTRATION".



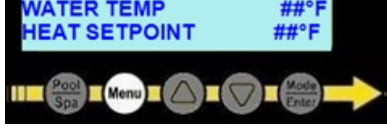



Enter "Shortcuts" menus, then proceed

<p><b>IF UNIT IS ASLEEP, SWIPE TO WAKE UP</b></p> 	<p><b>A PRESS MENU BUTTON</b></p> 	<p><b>B USE ARROWS TO "SHORTCUTS"</b></p> 
<p><b>C PRESS "ENTER"</b></p> 	<p><b>1 ARROWS TO SHORTCUT TO USE</b></p> 	<p><b>2 ENTER TO SELECT SHORTCUT</b></p> 
<p><b>3 ENTER TO START</b></p> 	<p><b>4 ARROWS TO MAXIMUM TIME TO OPERATE</b></p> 	<p><b>5 ENTER TO ACTIVATE</b></p> 
<p><b>MENU TO EXIT, PRESS &amp; HOLD TO STATUS</b></p> 	<p>On the status screen the group will show as active. It will then display the time remaining before the group expires.</p>	

### Stopping a Group Shortcut

In this example a group called "FILTRATION" is deactivated before it's time expires.

Enter "Shortcuts" menus, then proceed

<p><b>IF UNIT IS ASLEEP, SWIPE TO WAKE UP</b></p> 	<p><b>A PRESS MENU BUTTON</b></p> 	<p><b>B USE ARROWS TO "SHORTCUTS"</b></p> 
<p><b>C PRESS "ENTER"</b></p> 	<p><b>1 ARROWS TO SHORTCUT TO STOP</b></p> 	<p><b>2 ENTER TO SELECT</b></p> 

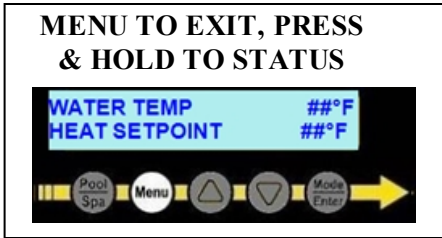
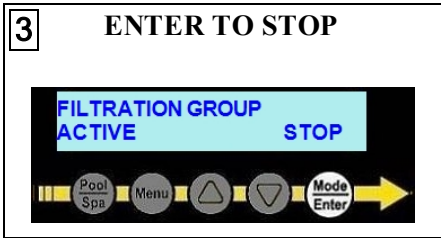

**1.8 Programming**

**IN THIS SECTION:**

1.8.a Setting Date and Time .....	10
1.8.b Setting Date and Time Format .....	11
1.8.c Selecting Celsius or Fahrenheit .....	12
1.8.d Setting Entry Code Option .....	13
1.8.e Disabling Entry Code Option .....	14
1.8.f Configuring Groups .....	15
f.1 Create a Group .....	15
f.2 Edit a Group .....	17
f.3 Delete a Group .....	18
1.8.g Configuring Schedules .....	18
g.1 Create a Schedule .....	19
g.2 Edit a Schedule .....	20
g.3 Delete a Schedule .....	21
1.8.h Schedule and Program Modes .....	23

**1.8.a Setting Date and Time**

The date and time are required in order to allow schedules to operate properly. Set the heat pump's date and time using the following steps.

**PLEASE NOTE:**  
If a PoolSync® device is attached and in-use, the time and date will automatically be set and maintained.

Enter "System" menus, then proceed

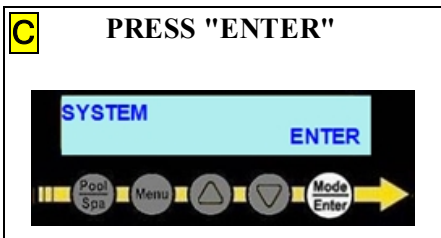
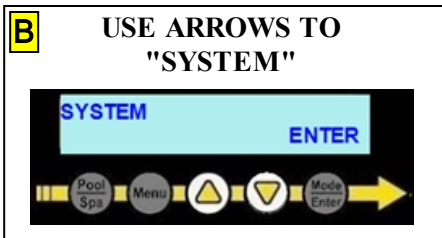
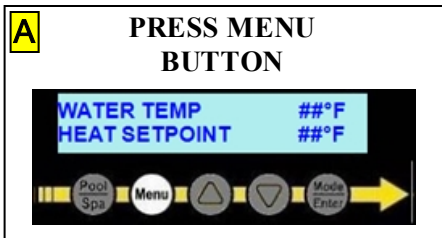
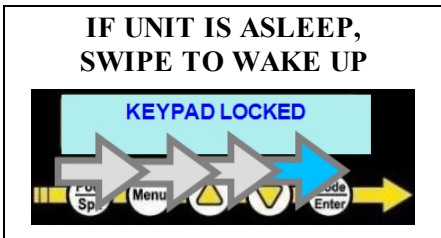

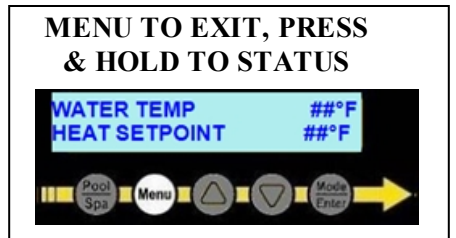
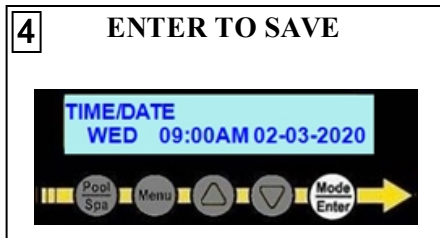

### 1.8.b Setting Date and Time Format

The heat pump's date and time format can be customized.

Customize Time

The time can be displayed in 24-hour *military* time (the default display is 12-hour).

Enter "System" menus, then proceed

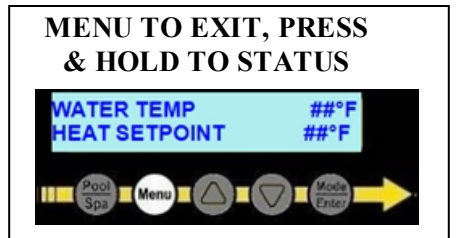
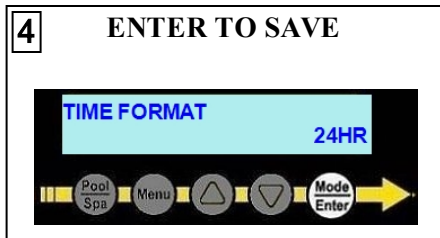
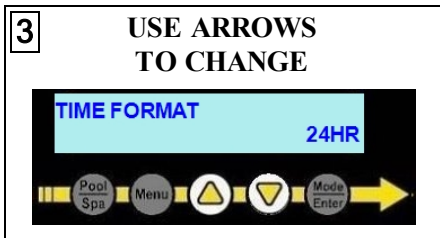
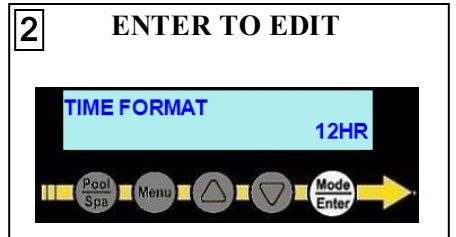
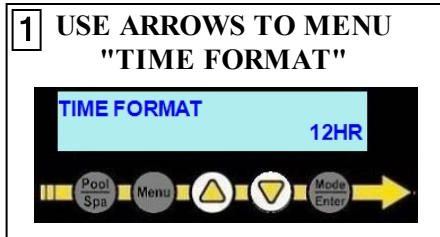
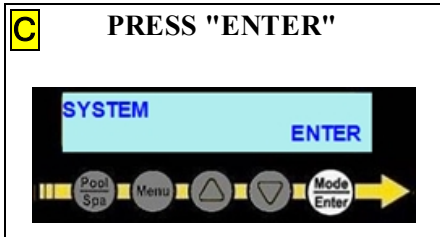
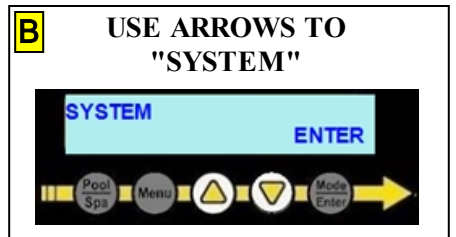
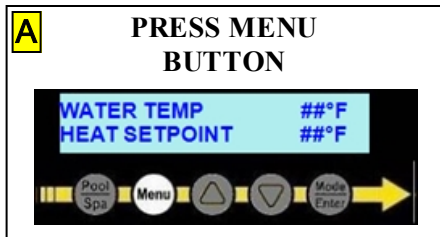
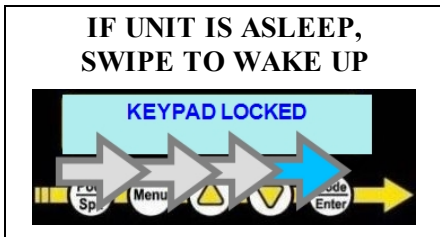





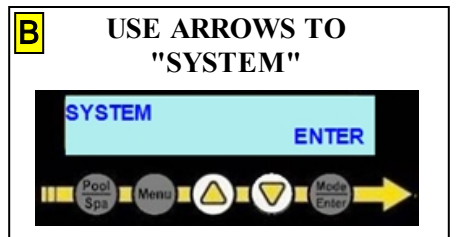
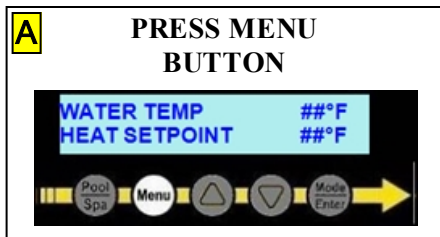
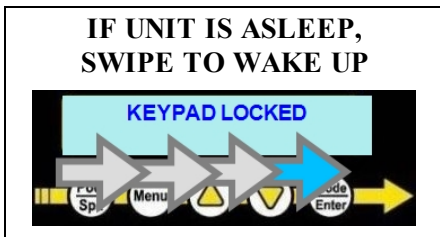

Customize Date

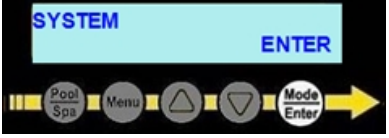
The date can be displayed as Day-Month-Year (the default is Month-Day-Year).

Enter "System" menus, then proceed

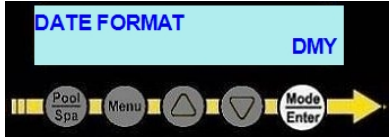







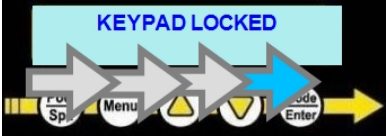

<b>C</b> PRESS "ENTER" 	<b>1</b> USE ARROWS TO MENU "DATE FORMAT" 	<b>2</b> ENTER TO EDIT 
<b>3</b> USE ARROWS TO CHANGE 	<b>4</b> ENTER TO SAVE 	MENU TO EXIT, PRESS & HOLD TO STATUS 

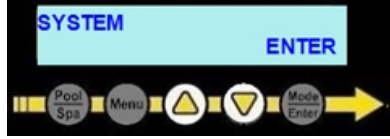
### 1.8.c Selecting Celsius or Fahrenheit

The user has the option of changing the way the water temperature is displayed. Either in Fahrenheit or Celsius. In the following example, the temperature units are changed from Fahrenheit to Celsius.

Enter "System" menus, then proceed

IF UNIT IS ASLEEP, SWIPE TO WAKE UP 	<b>A</b> PRESS MENU BUTTON 	<b>B</b> USE ARROWS TO "SYSTEM" 
<b>C</b> PRESS "ENTER" 	<b>1</b> USE ARROWS TO "TEMPERATURE UNITS" 	<b>2</b> ENTER TO EDIT 
<b>3</b> USE ARROWS TO CHANGE 	<b>4</b> ENTER TO SAVE 	MENU TO EXIT, PRESS & HOLD TO STATUS 



### 1.8.d Setting Entry Code Option

The entry code feature can prevent unauthorized access to the heat pump adjustments. This feature initiates after the heat pump goes into the sleep mode for the first time. This feature is commonly used on commercial applications.

#### NOTICE









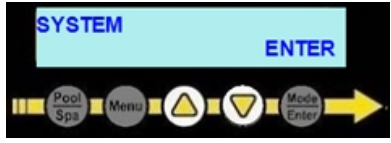
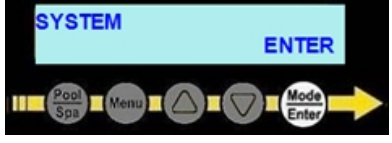
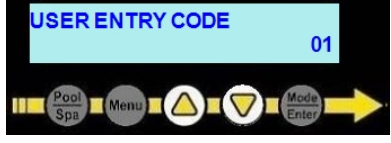
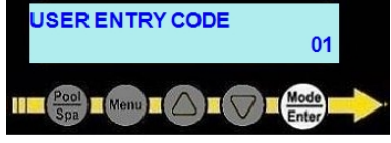

Failure to heed the following may result in damage to equipment.

- Before enabling the entry code feature, be sure to record the code. If lost, the heat pump will require a program reset to regain access. This reset may require additional configuration by the installer.

#### PLEASE NOTE -

A heat pump requesting an entry code is different than the control panel's sleep mode. (See "Wake Up Heat Pump" on page 3 for more information.)

Enter "System" menus, then proceed



<p><b>IF UNIT IS ASLEEP, SWIPE TO WAKE UP</b></p> 	<p><b>A PRESS MENU BUTTON</b></p> 	<p><b>B USE ARROWS TO "SYSTEM"</b></p> 
<p><b>C PRESS "ENTER"</b></p> 	<p><b>1 USE ARROWS TO MENU "USER ENTRY CODE"</b></p> 	<p><b>2 ENTER TO EDIT</b></p> 
<p><b>3 USE ARROWS TO CHANGE</b></p> 	<p><b>4 ENTER TO SAVE</b></p> 	<p><b>5 USE ARROWS TO MENU "USER CODE ENABLED"</b></p> 
<p><b>6 ENTER TO EDIT</b></p> 	<p><b>7 USE ARROWS TO CHANGE</b></p> 	<p><b>8 ENTER TO SAVE</b></p> 
<p><b>MENU TO EXIT, PRESS &amp; HOLD TO STATUS</b></p> 		

## 1.8.e Disabling Entry Code Option





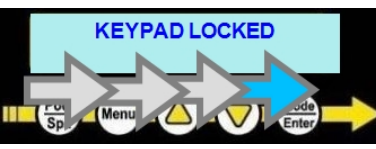

### PLEASE NOTE -

- If an entry code has already been activated, the code must be entered before proceeding to disable.

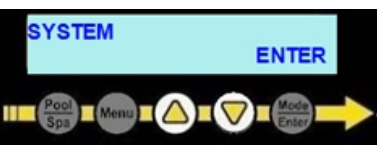
### Use Entry Code

<p><b>IF UNIT IS ASLEEP, SWIPE TO WAKE UP</b></p>  <p>KEYPAD LOCKED</p>	<p><b>1 USE ARROWS TO ENTER CODE</b></p>  <p>ENTRY CODE: 00</p>	<p><b>2 ENTER TO UNLOCK</b></p>  <p>ENTRY CODE: 01</p>
--	--	---

### Disable User Lock

<p><b>A PRESS MENU BUTTON</b></p>  <p>WATER TEMP ##°F HEAT SETPOINT ##°F</p>	<p><b>B USE ARROWS TO "SYSTEM"</b></p>  <p>SYSTEM ENTER</p>	<p><b>C PRESS "ENTER"</b></p>  <p>SYSTEM ENTER</p>
<p><b>3 USE ARROWS TO "USER ENTRY CODE ENABLED"</b></p>  <p>USER ENTRY CODE ENABLED ON</p>	<p><b>4 ENTER TO EDIT</b></p>  <p>USER ENTRY CODE ENABLED ON</p>	<p><b>5 ARROWS TO CHANGE</b></p>  <p>USER ENTRY CODE ENABLED OFF</p>
<p><b>6 ENTER TO SAVE</b></p>  <p>USER ENTRY CODE ENABLED OFF</p>	<p><b>MENU TO EXIT, PRESS &amp; HOLD TO STATUS</b></p>  <p>WATER TEMP ##°F HEAT SETPOINT ##°F</p>	

## 1.8.f Configuring Groups

A group is used to control multiple devices (equipment) connected to the heat pump, either by manually activating the group through a shortcut, or scheduling the group to activate at a specified time.

- See "Using Shortcuts" on page 8.
- See "Configuring Schedules" on page 18.

### **PLEASE NOTE:**

The Pool and Spa groups can be activated by pressing the "Pool / Spa" button on the control panel or scheduled to operate at a selected time.

- See "Display Panel" on page 4.

### **EXAMPLES IN THIS SECTION:**

f.1 Create a Group .....	15
f.2 Edit a Group .....	17
f.3 Delete a Group .....	18

## f.1 Create a Group

### **EXAMPLES OF GROUPS THAT CAN BE CREATED:**

- A Custom Filtration Group -
  - This group could be used if the user didn't want to regulate the temperature of the water the entire time the circulation pump is activated. A custom group can be created that separates the amount of filtration time from the amount of time allowed for the heat pump to heat or cool the water.

The example below shows a "FILTRATION" group being created manually.  
A circulation pump will be added to the group.

### **PLEASE NOTE**

This section only describes the configuration of an already connected circulation pump. To physically wire this type of device to the heat pump, see the heat pump's installation manual.

Enter "Groups" menus, then proceed

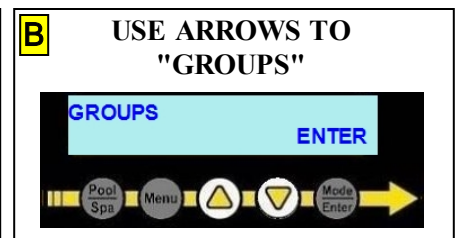
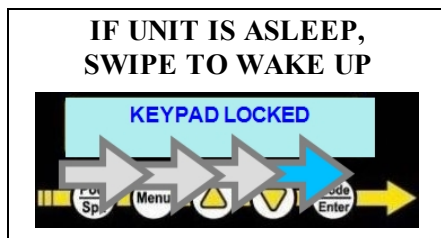

**C** PRESS "ENTER"

**1** USE ARROWS TO "NEW GROUP SETUP"

**2** ENTER TO CREATE

**3** USE ARROWS TO NAME "FILTRATION"

**4** ENTER TO SAVE

**5** USE ARROWS TO SET MAXIMUM ACTIVE TIME

**6** ENTER TO SAVE

**7** USE ARROWS TO SET FREEZE PROTECT OPTION

**8** ENTER TO SAVE

**9** PRESS BUTTON UNDER "YES" TO SAVE

**10** PRESS "ENTER" TO ADD EQUIPMENT

**11** USE ARROWS TO SELECT EQUIPMENT

**12** ENTER TO SAVE

**13** USE ARROWS TO SET RPM

**14** ENTER TO SAVE

**MENU TO EXIT, PRESS & HOLD TO STATUS**

The group is now ready to be activated using a shortcut or scheduled to activate at a certain time.

- See "Using a Group Shortcut" on page 9.
- See "Create a Schedule" on page 19.

## f.2 Edit a Group

The example below shows a "FILTRATION" group being edited.

An existing variable speed circulation pump will be deleted and an attached single speed circulation pump (named "POOL PUMP") will be added. The device will be set to be "ON" when the group is active.

Enter "Groups" menus, then proceed

<p><b>IF UNIT IS ASLEEP, SWIPE TO WAKE UP</b></p> 	<p><b>A</b> <b>PRESS "MENU" BUTTON</b></p> 	<p><b>B</b> <b>USE ARROWS TO "GROUPS"</b></p> 
<p><b>C</b> <b>PRESS "ENTER"</b></p> 	<p><b>1</b> <b>USE ARROWS TO "FILTRATION GROUP"</b></p> 	<p><b>2</b> <b>ENTER TO EDIT</b></p> 
<p><b>3</b> <b>USE ARROWS TO "REMOVE EQUIPMENT"</b></p> 	<p><b>4</b> <b>ENTER TO SELECT</b></p> 	<p><b>5</b> <b>USE ARROWS TO DEVICE TO REMOVE</b></p> 
<p><b>6</b> <b>ENTER TO SELECT</b></p> 	<p><b>7</b> <b>PRESS BUTTON UNDER "YES" TO CONFIRM</b></p> 	<p><b>8</b> <b>USE ARROWS TO "ADD EQUIPMENT"</b></p> 
<p><b>9</b> <b>ENTER TO SELECT</b></p> 	<p><b>10</b> <b>USE ARROWS TO DEVICE TO ADD</b></p> 	<p><b>11</b> <b>ENTER TO SELECT</b></p> 
<p><b>12</b> <b>USE ARROWS TO SELECT DEVICE STATE</b></p> 	<p><b>13</b> <b>ENTER TO SAVE</b></p> 	<p><b>MENU TO EXIT, PRESS &amp; HOLD TO STATUS</b></p> 

### f.3 Delete a Group

The example below shows a "FILTRATION" group being deleted.  
Any schedules associated with that group will also be deleted.

Enter "Groups" menus, then proceed

1 - Operation

**IF UNIT IS ASLEEP, SWIPE TO WAKE UP**

**A PRESS "MENU" BUTTON**

**B USE ARROWS TO "GROUPS"**

**C PRESS "ENTER"**

**1 USE ARROWS TO "DELETE GROUP"**

**2 ENTER TO SELECT**

**3 USE ARROWS TO GROUP TO BE DELETED**

**4 ENTER TO SELECT**

**5 PRESS BUTTON UNDER "YES" TO CONFIRM**

**MENU TO EXIT, PRESS & HOLD TO STATUS**

### 1.8.g Configuring Schedules

A schedule can be used to activate a group of devices at a specified time.

- See "Configuring Groups" on page 15.

**EXAMPLES IN THIS SECTION:**

g.1 Create a Schedule .....	19
g.2 Edit a Schedule .....	20
g.3 Delete a Schedule .....	21

## g.1 Create a Schedule

A maximum of four (4) schedule programs can be configured for each group.

The example below shows a "FILTRATION" group being scheduled.

Enter "Schedules" menus, then proceed

<p><b>IF UNIT IS ASLEEP, SWIPE TO WAKE UP</b></p> 	<p><b>A PRESS MENU BUTTON</b></p> 	<p><b>B USE ARROWS TO "SCHEDULES"</b></p> 
<p><b>C PRESS "ENTER"</b></p> 	<p><b>1 ARROWS TO GROUP TO SCHEDULE</b></p> 	<p><b>2 ENTER TO EDIT</b></p> 
<p><b>3 USE ARROWS TO THE PROGRAM TO SCHEDULE (1-4)</b></p> 	<p><b>4 ENTER TO EDIT</b></p> 	<p><b>5 USE ARROWS TO EDIT DAYS</b></p> 
<p><b>6 ENTER TO SAVE</b></p> 	<p><b>7 USE ARROWS TO "START" TIME</b></p> 	<p><b>8 ENTER TO EDIT</b></p> 
<p><b>9 USE ARROWS TO CHANGE</b></p> 	<p><b>10 ENTER TO SAVE</b></p> 	<p><b>11 USE ARROWS TO "END" TIME</b></p> 
<p><b>12 ENTER TO EDIT</b></p> 	<p><b>13 USE ARROWS TO CHANGE</b></p> 	<p><b>14 ENTER TO SAVE</b></p> 

**MENU TO EXIT, PRESS & HOLD TO STATUS**



**g.2 Edit a Schedule**

The example below shows a pool group schedule being edited:

- From 8:00AM-5:00PM SMTWTFS (everyday)
- To 9:00AM-6:00PM -MTWTF- (Monday through Friday)

**! WARNING**

Failure to heed the following may result in injury or death.

- When editing schedules containing the circulation pump, allow time for proper filtration.
- Follow all State and Local guidelines in regards to satisfying code-specified whole system turnover rates.

**PLEASE NOTE:**

*This is not a recommended filtration schedule.*

- What is shown is just an example of how to edit a schedule.
- The default schedule was initially created using one of the presets in the installer wizard.

Enter "Schedules" menus, then proceed

<p><b>IF UNIT IS ASLEEP, SWIPE TO WAKE UP</b></p>	<p><b>A PRESS MENU BUTTON</b></p>	<p><b>B USE ARROWS TO "SCHEDULES"</b></p>
<p><b>C PRESS "ENTER"</b></p>	<p><b>1 USE ARROWS TO "POOL GROUP"</b></p>	<p><b>2 PRESS ENTER TO EDIT</b></p>
<p><b>3 USE ARROWS TO SCHEDULE TO EDIT</b></p>	<p><b>4 ENTER TO EDIT</b></p>	<p><b>5 USE ARROWS TO "PROGRAM 1 DAYS"</b></p>



<p><b>6</b> ENTER TO EDIT</p>	<p><b>7</b> USE ARROWS TO CHANGE</p>	<p><b>8</b> ENTER TO SAVE</p>
<p><b>9</b> USE ARROWS TO "PROGRAM1 START"</p>	<p><b>10</b> ENTER TO EDIT</p>	<p><b>11</b> USE ARROWS TO CHANGE</p>
<p><b>12</b> ENTER TO SAVE</p>	<p><b>13</b> USE ARROWS TO "PROGRAM1 END"</p>	<p><b>14</b> ENTER TO EDIT</p>
<p><b>15</b> USE ARROWS TO CHANGE</p>	<p><b>16</b> ENTER TO SAVE</p>	<p>MENU TO EXIT, PRESS &amp; HOLD TO STATUS</p>

**g.3 Delete a Schedule**

Select the group and then the program to edit. Use the clear option to remove the program's schedule.

In the following example, the group "FILTRATION" has a schedule in "PROGRAM 1" that will be cleared (deleted).

Enter "Schedules" menus, then proceed

<p><b>IF UNIT IS ASLEEP, SWIPE TO WAKE UP</b></p>	<p><b>A</b> PRESS MENU BUTTON</p>	<p><b>B</b> USE ARROWS TO "SCHEDULES"</p>
---	-----------------------------------	---

**C** PRESS "ENTER"

The screenshot shows a control panel with a display showing "SCHEDULES" and "ENTER". Below the display are buttons for "Pool Spa", "Menu", an up arrow, a down arrow, and "Mode Enter". A yellow arrow points to the "Mode Enter" button.

**1** ARROWS TO SCHEDULED GROUP

The screenshot shows a control panel with a display showing "FILTRATION GROUP" and "EDIT". Below the display are buttons for "Pool Spa", "Menu", an up arrow, a down arrow, and "Mode Enter". A yellow arrow points to the down arrow button.

**2** ENTER TO EDIT

The screenshot shows a control panel with a display showing "FILTRATION GROUP" and "EDIT". Below the display are buttons for "Pool Spa", "Menu", an up arrow, a down arrow, and "Mode Enter". A yellow arrow points to the "Mode Enter" button.

**3** USE ARROWS TO PROGRAM TO EDIT

The screenshot shows a control panel with a display showing "PROGRAM 1", "SMTWTFS", and "08:00AM-06:00PM" with "EDIT" below it. Below the display are buttons for "Pool Spa", "Menu", an up arrow, a down arrow, and "Mode Enter". A yellow arrow points to the down arrow button.

**4** ENTER TO EDIT

The screenshot shows a control panel with a display showing "PROGRAM 1", "SMTWTFS", and "08:00AM-06:00PM" with "EDIT" below it. Below the display are buttons for "Pool Spa", "Menu", an up arrow, a down arrow, and "Mode Enter". A yellow arrow points to the "Mode Enter" button.

**5** USE ARROWS TO "CLEAR"

The screenshot shows a control panel with a display showing "PROGRAM 1" and "CLEAR". Below the display are buttons for "Pool Spa", "Menu", an up arrow, a down arrow, and "Mode Enter". A yellow arrow points to the down arrow button.

**6** ENTER TO SELECT

The screenshot shows a control panel with a display showing "PROGRAM 1" and "CLEAR". Below the display are buttons for "Pool Spa", "Menu", an up arrow, a down arrow, and "Mode Enter". A yellow arrow points to the "Mode Enter" button.

**7** SELECT "YES" TO CLEAR PROGRAM

The screenshot shows a control panel with a display showing "CLEAR PROGRAM?" and "YES" with "NO" below it. Below the display are buttons for "Pool Spa", "Menu", an up arrow, a down arrow, and "Mode Enter". A yellow arrow points to the "Mode Enter" button.

MENU TO EXIT, PRESS & HOLD TO STATUS

The screenshot shows a control panel with a display showing "WATER TEMP" and "HEAT SETPOINT" with "##°F" below it. Below the display are buttons for "Pool Spa", "Menu", an up arrow, a down arrow, and "Mode Enter". A yellow arrow points to the "Mode Enter" button.

## 1.8.h Schedule and Program Modes

Schedules can be deactivated temporarily as needed. Either globally through a schedule mode, or individually by setting a group's program mode.

SCHEDULE MODE	Description	
"AUTO"	The default mode. This allows schedules to run normally.	See "Set Schedule Mode to "AUTO"" below.
"AWAY"	This mode is generally used when the user is away on vacation and doesn't want to maintain a water temperature. The heat pump will be deactivated while the rest of the schedules (including filtration) are allowed to continue.	See "Set Schedule Mode to "AWAY"" on the next page.
"OFF"	This mode turns off all schedules. The schedules resume when the schedule mode is set to "AUTO" again. Please note - this will also halt any connected circulation pump activity. This option is not meant for long term usage.	See "Set Schedule Mode to "OFF"" on page 25.

PROGRAM MODE	Description	
"ON"	A group's scheduled programs are set to operate normally.	See "Set Group Programs to "ON"" on page 25.
"PAUSED"	A group's scheduled programs will be paused. The programs will automatically resume the next scheduled day. No other group's activities will be effected.	See "Set Group Programs to "PAUSED"" on page 26.
"OFF"	This mode turns off all schedule programs for the group indefinitely. Programs resume when the program mode is set to "ON" again.	See "Set Group Programs to "OFF"" on page 27.

Set Schedule Mode to "AUTO"

Enter "Shortcuts" menus, then proceed

**IF UNIT IS ASLEEP, SWIPE TO WAKE UP**









**A PRESS MENU BUTTON**



**B USE ARROWS TO "SHORTCUTS"**











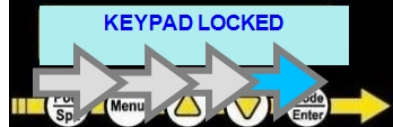

<b>C</b> PRESS "ENTER" 	<b>1</b> ARROWS TO "SCHEDULE MODE" 	<b>2</b> ENTER TO EDIT 
<b>3</b> ARROWS TO "AUTO" 	<b>4</b> ENTER TO SAVE 	MENU TO EXIT, PRESS & HOLD TO STATUS 

Set Schedule Mode to "AWAY"







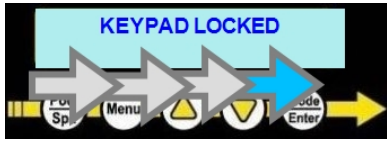

Enter "Shortcuts" menus, then proceed

1 - Operation

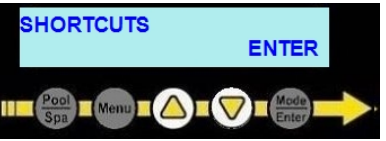
IF UNIT IS ASLEEP, SWIPE TO WAKE UP 	<b>A</b> PRESS MENU BUTTON 	<b>B</b> USE ARROWS TO "SHORTCUTS" 
<b>C</b> PRESS "ENTER" 	<b>1</b> ARROWS TO "SCHEDULE MODE" 	<b>2</b> ENTER TO EDIT 
<b>3</b> ARROWS TO "AWAY" 	<b>4</b> ENTER TO SAVE 	<b>5</b> ARROWS AND ENTER TO SET END DATE 
MENU TO EXIT, PRESS & HOLD TO STATUS 		

Set Schedule Mode to "OFF"



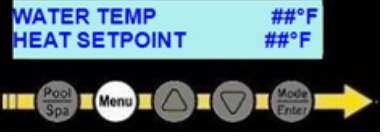

Enter "Shortcuts" menus, then proceed

<p><b>IF UNIT IS ASLEEP, SWIPE TO WAKE UP</b></p> 	<p><b>A PRESS MENU BUTTON</b></p> 	<p><b>B USE ARROWS TO "SHORTCUTS"</b></p> 
<p><b>C PRESS "ENTER"</b></p> 	<p><b>1 ARROWS TO "SCHEDULE MODE"</b></p> 	<p><b>2 ENTER TO EDIT</b></p> 
<p><b>3 ARROWS TO "OFF"</b></p> 	<p><b>4 ENTER TO SAVE</b></p> 	<p><b>MENU TO EXIT, PRESS &amp; HOLD TO STATUS</b></p> 

Set Group Programs to "ON"

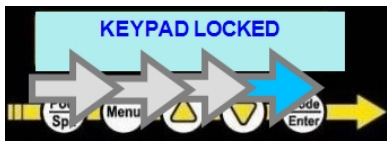
In the following example, the "Pool" group's set of scheduled programs will be set from "PAUSED" back to "ON".

Enter "Schedules" menus, then proceed

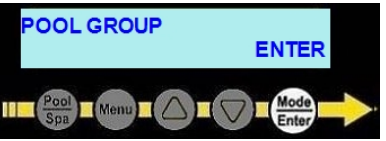
<p><b>IF UNIT IS ASLEEP, SWIPE TO WAKE UP</b></p> 	<p><b>A PRESS MENU BUTTON</b></p> 	<p><b>B USE ARROWS TO "SCHEDULES"</b></p> 
<p><b>C PRESS "ENTER"</b></p> 	<p><b>1 ARROWS TO "POOL GROUP"</b></p> 	<p><b>2 ENTER TO EDIT</b></p> 

**3**      **ARROWS TO "PROGRAM MODE"**

**4**      **ENTER TO EDIT**

**5**      **ARROWS TO "ON"**

**6**      **ENTER TO SAVE**

**MENU TO EXIT, PRESS & HOLD TO STATUS**

Set Group Programs to "PAUSED"

In the following example, the "Pool" group's set of scheduled programs will be paused. This will continue until the programs are set back to "ON".

Enter "Schedules" menus, then proceed

**IF UNIT IS ASLEEP, SWIPE TO WAKE UP**

**A**      **PRESS MENU BUTTON**

**B**      **USE ARROWS TO "SCHEDULES"**

**C**      **PRESS "ENTER"**

**1**      **ARROWS TO "POOL GROUP"**

**2**      **ENTER TO EDIT**

**3**      **ARROWS TO "PROGRAM MODE"**

**4**      **ENTER TO EDIT**

**5**      **ARROWS TO "PAUSED"**

**6**      **ENTER TO SAVE**

**MENU TO EXIT, PRESS & HOLD TO STATUS**

Set Group Programs to "OFF"

In the following example, the "Pool" group's set of scheduled programs will be set from "ON" to "OFF".

The schedules will not resume until the programs are set back to "ON".

Enter "Schedules" menus, then proceed

**IF UNIT IS ASLEEP, SWIPE TO WAKE UP**  
 KEYPAD LOCKED  
 Pool Spa Menu Mode Enter

**A PRESS MENU BUTTON**  
 WATER TEMP ##°F  
 HEAT SETPOINT ##°F  
 Pool Spa Menu Mode Enter

**B USE ARROWS TO "SCHEDULES"**  
 SCHEDULES ENTER  
 Pool Spa Menu Mode Enter

**C PRESS "ENTER"**  
 SCHEDULES ENTER  
 Pool Spa Menu Mode Enter

**1 ARROWS TO "POOL GROUP"**  
 POOL GROUP ENTER  
 Pool Spa Menu Mode Enter

**2 ENTER TO EDIT**  
 POOL GROUP ENTER  
 Pool Spa Menu Mode Enter

**3 ARROWS TO "PROGRAM MODE"**  
 PROGRAM MODE ON  
 Pool Spa Menu Mode Enter

**4 ENTER TO EDIT**  
 PROGRAM MODE ON  
 Pool Spa Menu Mode Enter

**5 ARROWS TO "OFF"**  
 PROGRAM MODE OFF  
 Pool Spa Menu Mode Enter

**6 ENTER TO SAVE**  
 PROGRAM MODE OFF  
 Pool Spa Menu Mode Enter

**MENU TO EXIT, PRESS & HOLD TO STATUS**  
 WATER TEMP ##°F  
 HEAT SETPOINT ##°F  
 Pool Spa Menu Mode Enter

1.9 External Equipment

**IN THIS SECTION:**

1.9.a PoolSync® .....	28
1.9.b Operating Heat Pump (With an External Controller) .....	29
1.9.c Operating Heat Pump (With an External Flow Switch) .....	29
1.9.d Operating Multiple Connected Heat Pumps .....	29

## 1.9.a PoolSync®



Select heat pumps (with an HP9 control board installed) will automatically allow for WI-FI capabilities using a PoolSync®.





- The PoolSync® device will allow direct control of the heat pump from a mobile device.
- Contact installing dealer to order this product.
- Go online and download the PoolSync® manual for information on connecting and using this device with an AquaCal heat pump. <https://www.aquacal.com/owners-manuals/>
- Confirm the PoolSync® has been set as an active external control device. See "Confirm PoolSync® is set to operate" below.

### Confirm PoolSync® is set to operate

The heat pump has this device active by default. In this example, however, the heat pump is reconfigured to use the PoolSync® device instead of a prior configuration of a "SMART" external controller.

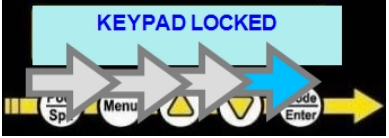
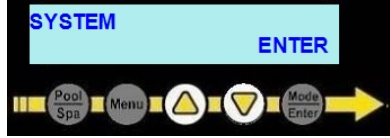
Enter "Advanced" menus, then proceed

1 - Operation

<p><b>IF UNIT IS ASLEEP, SWIPE TO WAKE UP</b></p> 	<p><b>A PRESS MENU BUTTON</b></p> 	<p><b>B USE ARROWS TO "SYSTEM"</b></p> 
<p><b>C PRESS "ENTER"</b></p> 	<p><b>D USE ARROWS TO "ADVANCED"</b></p> 	<p><b>E PRESS "ENTER"</b></p> 
<p><b>1 USE ARROWS TO "EXTERNAL CONTROL"</b></p> 	<p><b>2 ENTER TO SELECT</b></p> 	<p><b>3 ARROWS TO MODE</b></p> 
<p><b>4 ENTER TO EDIT</b></p> 	<p><b>5 ARROWS TO "POOLSUNC"</b></p> 	<p><b>6 ENTER TO SELECT</b></p> 



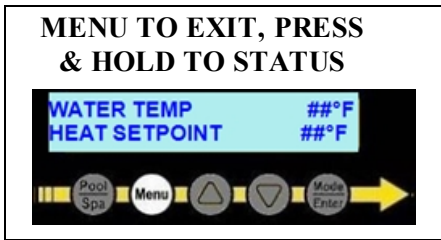

**1.9.b Operating Heat Pump (With an External Controller)**

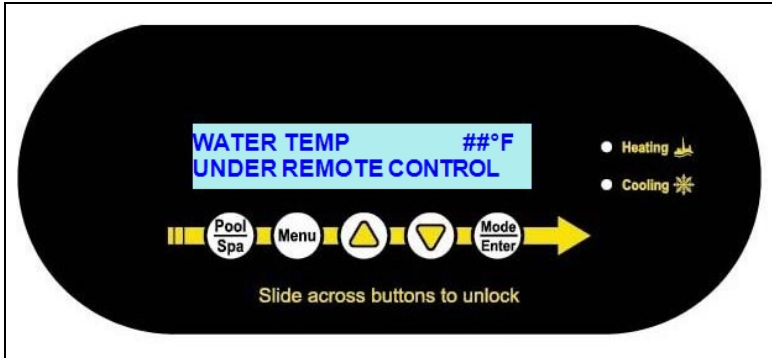

If the display indicates the unit is under remote control, an external control device has been configured to control the heat pump. See the external control device manual. Or contact installer or manufacturer of that device.

**PLEASE NOTE:**  
*When using a SMART external control device, the time-out and service modes will deactivate the Heat Pump.*

**1.9.c Operating Heat Pump (With an External Flow Switch)**

When an external flow switch has been installed and enabled, the heat pump will automatically switch from pool to spa temperature settings when there is flow through the external flow switch. The "Pool/Spa" button will be disabled when this device is configured in the system.

Confirm with the installer if an external flow switch has been installed on the system.

**1.9.d Operating Multiple Connected Heat Pumps**

Each heat pump will indicate whether it is a primary or secondary unit on the display. Changes in mode and operation are made on the primary heat pump only.

- The primary heat pump will automatically start and stop the secondary heat pumps in a timed and controlled sequence.

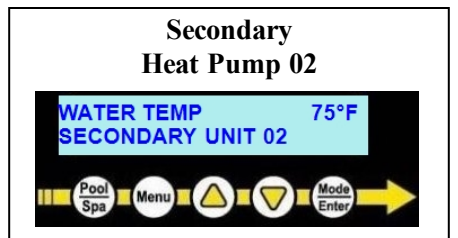
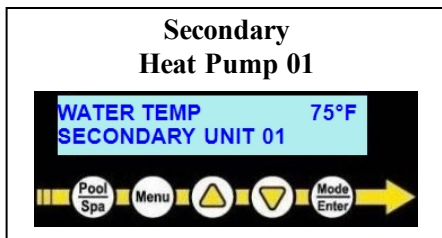
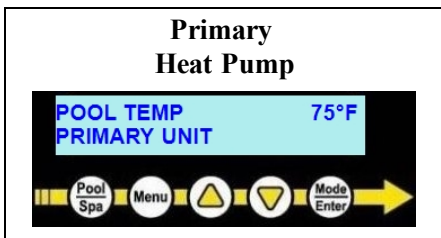

## 2 - Maintenance

### IN THIS SECTION:

2.1 Water Chemistry .....	30
2.2 Cleaning Equipment .....	31
2.3 Clearances .....	32
2.4 Irrigation and Storm Run-Off .....	33
2.5 Water Flow Rates .....	33
2.6 Planned Maintenance .....	34
2.7 Freeze Protection .....	35
2.8 Winterizing .....	38

### 2.1 Water Chemistry

Check water chemistry regularly and maintain within recommended levels. Standards vary in different residential and commercial applications. Follow all local applicable codes.

#### NOTICE

Failure to heed the following may result in damage to equipment.

- Do not allow water to flow through the heat pump when refinishing or acid washing a pool. Use an installed bypass to route water away from the heat pump or deactivate the filter pump.
- To avoid damage to equipment, monitor and maintain chemistry within recommended levels.

#### CHEMISTRY LEVEL CHART (RESIDENTIAL)

CHEMICAL	POOLS	SPAS
<b>Chlorine</b>	1.0 – 3.0 ppm (1 – 3 mg/L)	3.0 – 5.0 ppm (3 – 5 mg/L)
<b>Bromine</b>	2.0 – 6.0 ppm (2 – 6 mg/L)	2.0 – 6.0 ppm (2 – 6 mg/L)
<b>Cyanuric Acid</b>	30 – 50 ppm (30 – 50 mg/L)	30 – 50 ppm (30 – 50 mg/L)
<b>pH</b>	7.4 – 7.6	7.4 – 7.6
<b>Total Alkalinity</b>	80 – 120 ppm (80 – 120 mg/L)	80 – 120 ppm (80 – 120 mg/L)
<b>Calcium Hardness</b>	200 – 400 ppm (200 – 400 mg/L)	150 – 250 ppm (150 – 250 mg/L)
<b>Total Dissolved Solids*</b>	0 – 1500 ppm (0 – 1.5 g/L)	1500 (1.5 g/L) ppm above start-up of total dissolved solids in spas

\* Salt from a chlorine generator is not included in Total Dissolved Solids.

## 2.2 Cleaning Equipment

Cleaning and polishing the heat pump regularly can protect its appearance and longevity. More frequent servicing may be required for heat pumps located in sandy or coastal areas where sand and salt spray can damage equipment.



### WARNING

Failure to heed the following may result in injury or death.

- Possible electric shock hazard - Deactivate power to all electrical devices on the pad when washing heat pump. Do not restore electrical power until equipment is completely dry.

### NOTICE

Failure to heed the following may result in damage to equipment.

- Do not use a pressure cleaner to wash the heat pump. Damage to heat pump components may result. If using a hose-end spray nozzle adjust the spray pattern to low strength only.
- Do not spray water directly into the interior of the heat pump; damage to components may result.
- Do not use chemicals on the display panel.

### Cleaning

1. Wash cabinet using a low-pressure water hose. A high-pressure water stream will cause damage to the aluminum fins of the heat pump. This damage is not covered under the product warranty.
2. While the heat pump is still wet, use an approved cleaning agent to clean the exterior of the heat pump. **Do not use chemicals on the display panel.**
3. Use a detergent-dampened cloth to wipe the heat pump's exterior cabinet.
4. Flush all exterior with fresh water using a low-pressure water hose.
5. Dry the cabinet using a soft cloth being careful not to damage fins.

APPROVED CLEANING AGENTS*
Fantastic®
Formula 409®
Cascade®
All Power Plain Detergent (3% Solution)

Table 1 - Cleaning Agents

- \* The trademarks used in approved cleaning agents are the property of their owners and are not related to AquaCal®.

## Polishing

1. Polish the heat pump's cabinet panels using an approved polishing agent and following the manufacturer's instructions. **Do not use chemicals on the display panel.**
2. Rinse the heat pump panels with fresh water, wipe, and buff panels using a dry soft cloth.
3. Allow heat pump interior and surrounding equipment to "air-dry" for several hours prior to restoring electrical power.

### APPROVED POLISHING AGENTS\*

Simoniz® Wax

Glo-Coat®

Armor All® Protectant

Table 2 - Polishing Agents

- \* The trademarks used in approved polishing agents are the property of their owners and are not related to AquaCal®.

## 2.3 Clearances

- Proper air circulation is required for the heat pump to operate efficiently. The following diagrams show the minimum clearances required for the proper operation of the heat pump.
- Avoid placing objects near or on top of the heat pump. This includes shrubbery and lawn furniture. These objects will reduce performance and efficiency and hinder maintenance access.

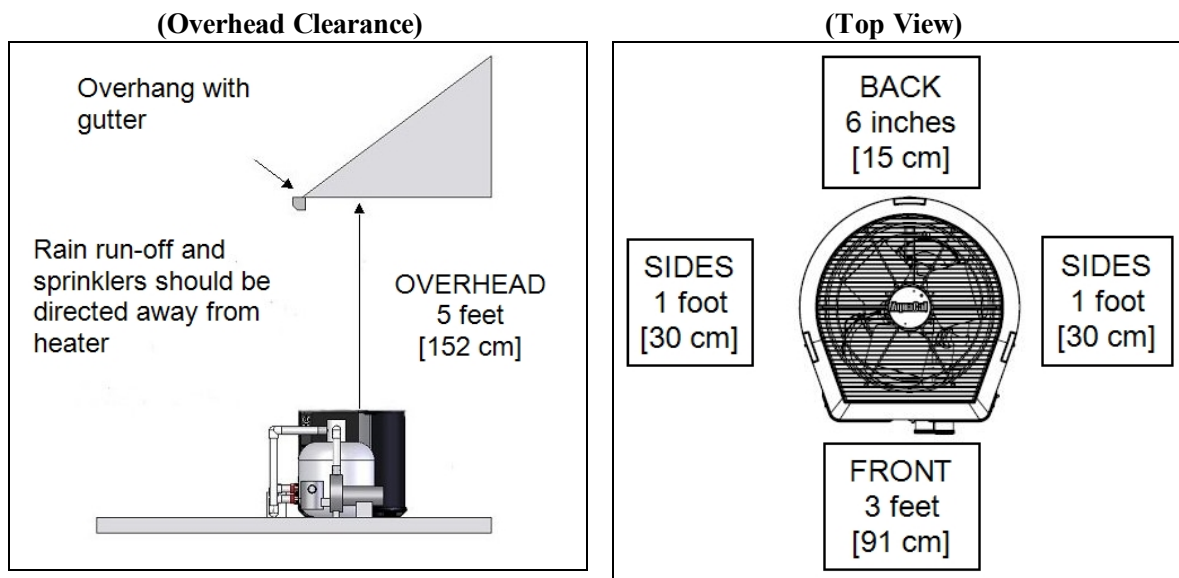

(Top View)  
TropiCal® T170

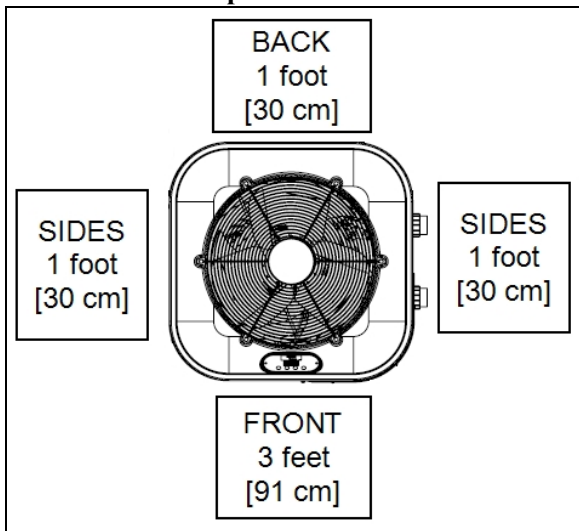

## 2.4 Irrigation and Storm Run-Off

- Irrigation water may damage heat pump components. Direct irrigation water away from the heat pump.
- The heat pump will withstand normal rainfall. Do not allow a roof slope to direct rainwater onto the heat pump. Have a gutter installed on the roof edge to direct this water away from the heat pump. Or install the heat pump in another location.

## 2.5 Water Flow Rates

- Maintain water flow rates as indicated. Please note, these specifications relate to the heat pump only. Code-specified whole system turnover rates must be satisfied.
- To adjust water flow rates, see "*Adjusting Water Flow Using  $\Delta T$  (Delta-T)*" on page 41.

### NOTICE

Failure to heed the following may result in damage to equipment.

- Water flow exceeding maximum flow rates will negatively affect the total pool filtration performance and may damage the heat pump. This will not be covered under the equipment warranty.

MODEL	HEAT EXCHANGER TYPE	FLOW RATES	
		MINIMUM	MAXIMUM
SQ120R	Titanium ThermoLink®	30 GPM (113.6 L/min)	70 GPM (265 L/min)
SQ125	Titanium ThermoLink®	30 GPM (113.6 L/min)	70 GPM (265 L/min)
SQ145	Titanium ThermoLink®	30 GPM (113.6 L/min)	70 GPM (265 L/min)
SQ150VS	Titanium ThermoLink®	30 GPM (113.6 L/min)	70 GPM (265 L/min)
SQ166R	Titanium ThermoLink®	30 GPM (113.6 L/min)	70 GPM (265 L/min)
SQ225	Titanium ThermoLink®	30 GPM (113.6 L/min)	70 GPM (265 L/min)
T035	Titanium Tube-in-Tube	20 GPM (75.7 L/min)	45 GPM (170 L/min)
T055	Titanium Tube-in-Tube	20 GPM (75.7 L/min)	45 GPM (170 L/min)
T075	Titanium Tube-in-Tube	20 GPM (75.7 L/min)	45 GPM (170 L/min)
T090	Titanium ThermoLink®	30 GPM (113.6 L/min)	70 GPM (265 L/min)

MODEL	HEAT EXCHANGER TYPE	FLOW RATES	
		MINIMUM	MAXIMUM
T115	Titanium ThermoLink <sup>®</sup>	30 GPM (113.6 L/min)	70 GPM (265 L/min)
T135	Titanium ThermoLink <sup>®</sup>	30 GPM (113.6 L/min)	70 GPM (265 L/min)
T170	Titanium Tube-in-Tube	30 GPM (113.6 L/min)	70 GPM (265 L/min)
TC500	Titanium Tube-in-Tube	20 GPM (75.7 L/min)	45 GPM (170 L/min)
TC1000	Titanium ThermoLink <sup>®</sup>	30 GPM (113.6 L/min)	70 GPM (265 L/min)
TC1500	Titanium ThermoLink <sup>®</sup>	30 GPM (113.6 L/min)	70 GPM (265 L/min)

**PLEASE NOTE -**

If minimum flow rates are not met, heat pump performance is reduced and performance will suffer. Internal safety devices may deactivate the heat pump with the following errors:

- Operate water filtration devices per manufacturer's specifications. Dirty filters can cause a reduction of water flow to the heat pump. An increase of 7-10 psi (48 to 69 kPa) higher than the clean filter pressure typically reduces flow rates. This requires the filter to be cleaned or back-washed.
- Keep baskets free of debris. A large quantity of debris in the pump and skimmer baskets can reduce water flow.
- Check for improper valve settings. A partially closed valve after the filter, or a full-open bypass around the heat pump, will cause insufficient water flow through the heat pump.
- The maximum static pressure (or operating pressure) is 50 psi (345 kPa). These specifications relate to the heat pump only.
- Code-specified whole system turnover rates must be satisfied.

**2.6 Planned Maintenance**

An annual inspection and maintenance program is strongly recommended starting no later than one year after installation of the heat pump. In harsh environments or coastal areas, a bi-annual inspection is recommended. See the recommended inspection checklist.

AquaCal<sup>®</sup> can perform this service in limited areas. Contact Customer Support for more information.

**⚠ DANGER**

Failure to heed the following will result in injury or death.

- Deactivate power while routing wiring to control board.
- RISK OF ELECTRICAL SHOCK FROM ENERGY STORED IN CAPACITORS - MODELS EQUIPPED WITH VARIABLE FREQUENCY COMPRESSOR DRIVES STORE ELECTRICITY EVEN AFTER THE POWER HAS BEEN DEACTIVATED AT THE POWER BREAKER. ***Wait for 2 minutes after the shut down of equipment before servicing.***
- Follow all National Electric Codes (NEC) and/or State and Local guidelines.

**⚠ WARNING**

Failure to heed the following may result in injury or death.

- Annual inspection and service must be performed by a qualified heat pump specialist in order to prevent physical injury or damage to equipment. For tasks requiring handling refrigerant, an HVAC license is required.

<b>Recommended Inspection Checklist:</b>
1. Clean Evaporator Coil (As Applicable)
2. Clean Condenser Coil (As Applicable)
3. Check Contactor Points
4. Check Fan Capacitor Values
5. Check Fan Blade Clearances
6. Clean Heat Pump Cabinet
7. Check Flow / Pressure Switch
8. Apply Rust Inhibitors (As applicable)
9. Verify / Check Air Flow Delta-T
10. Verify / Check Water Flow Delta-T
11. Check Fan Motor Amperage Draw
12. Check and Clear Condensate Drains
13. Check Compressor Capacitor Values
14. Check Compressor Amperage Draw
15. Check Internal Electrical Connections
16. Check Operating Refrigerant Pressures (As Applicable)
17. Check Ambient and Water Temperature Sensors
18. Check Proper Line and Control Voltage to Unit
19. Identify Insect and Rodent Issues with Unit
20. Identify Environmental Conditions of Concern (Run-Off, Sprinklers, etc.)
21. Perform Operating Orientation (As Applicable)

## 2.7 Freeze Protection

When freeze protection is active, water is circulated through designated group's plumbing circuits in 5 minute cycles. The water circulation lowers the chances of water freezing in those circuits.

- Freeze protection will automatically activate when the air temperature falls below 37° F (3° C).
- When the air temperature rises to 43° F (6° C), freeze protection will deactivate.
- These set temperatures and cycle times can be adjusted as needed in settings. See "*Adjusting Freeze Protection Options*" on the next page.

### **PLEASE NOTE:**

- Freeze protection is meant to be temporary. If freezing temperatures will continue for an extended time frame, the pool equipment ***must*** be winterized.
- The heat pump will not attempt to heat water in freezing conditions.
- As a group cycles on and off, any devices contained within that group will also cycle on and off. If this behavior is undesirable, the device can either be removed from the group or manually deactivated.









## Requirements for Freeze Protection

- A circulation pump must exist in the group to be protected.
- Water flow must be properly directed through the group's plumbing circuit via valve actuators.
- The group's freeze protection option must be set to on.

Adjusting Groups to Allow Freeze Protection

In the following example, a "FOUNTAIN" group is edited to enable freeze protection.

Enter "Groups" menus, then proceed

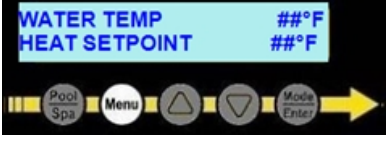
<p><b>IF UNIT IS ASLEEP, SWIPE TO WAKE UP</b></p> 	<p><b>A PRESS "MENU" BUTTON</b></p> 	<p><b>B USE ARROWS TO "GROUPS"</b></p> 
<p><b>C PRESS "ENTER"</b></p> 	<p><b>1 USE ARROWS TO GROUP TO EDIT</b></p> 	<p><b>2 PRESS "ENTER" TO EDIT</b></p> 
<p><b>3 ARROWS TO "FREEZE PROTECT ENABLED"</b></p> 	<p><b>4 PRESS "ENTER" TO EDIT</b></p> 	<p><b>5 USE ARROWS TO CHANGE TO "ON"</b></p> 
<p><b>MENU TO EXIT, PRESS &amp; HOLD TO STATUS</b></p> 		

Adjusting Freeze Protection Options

In the following example, the time is adjusted to cycle water between circuits from 5 minutes to 10 minutes.

**NOTICE**

Failure to heed the following may result in damage to equipment.











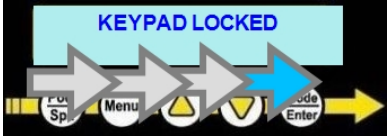

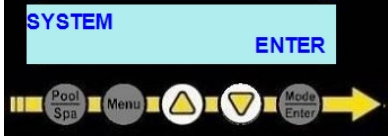
- Use extreme care when setting and adjusting freeze protection options. Improper freeze protection settings can cause damage to equipment. This is not covered by heat pump warranty.



Available freeze protection options:

- "PROTECT ON SETPOINT" can be adjusted from 33° F to 39° F (.6° C to 4° C). The default is 37° F (3° C).
- "PROTECT OFF SETPOINT" can be adjusted from 40° F to 45° F (4° C to 7° C). The default is 43° F (6° C).
- "CYCLE TIME" can be adjusted from 5 to 20 minutes.

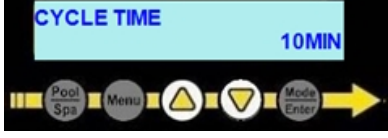
Enter "Advanced" menus, then proceed

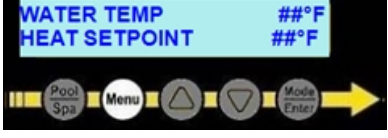
<p><b>IF UNIT IS ASLEEP, SWIPE TO WAKE UP</b></p> 	<p><b>A PRESS MENU BUTTON</b></p> 	<p><b>B USE ARROWS TO "SYSTEM"</b></p> 
<p><b>C PRESS "ENTER"</b></p> 	<p><b>D USE ARROWS TO "ADVANCED"</b></p> 	<p><b>E PRESS "ENTER"</b></p> 
<p><b>1 USE ARROWS TO MENU "FREEZE PROTECT"</b></p> 	<p><b>2 PRESS "ENTER" TO EDIT</b></p> 	<p><b>3 USE ARROWS TO "CYCLE TIME"</b></p> 
<p><b>4 PRESS "ENTER" TO EDIT</b></p> 	<p><b>5 USE ARROWS TO EDIT</b></p> 	<p><b>6 PRESS "ENTER" TO SAVE</b></p> 
<p><b>MENU TO EXIT, PRESS &amp; HOLD TO STATUS</b></p> 		

## 2.8 Winterizing

Failure to properly winterize the heat pump as needed may result in serious equipment damage.

### DANGER

Failure to heed the following will result in injury or death.

- Deactivate power while routing wiring to control board.
- RISK OF ELECTRICAL SHOCK FROM ENERGY STORED IN CAPACITORS - MODELS EQUIPPED WITH VARIABLE FREQUENCY COMPRESSOR DRIVES STORE ELECTRICITY EVEN AFTER THE POWER HAS BEEN DEACTIVATED AT THE POWER BREAKER. ***Wait for 2 minutes after the shut down of equipment before servicing.***
- Follow all National Electric Codes (NEC) and/or State and Local guidelines.

### WARNING

Failure to heed the following may result in injury or death.

- Deactivate all electrical power to heat pump before performing hard freeze procedures.

### NOTICE

Failure to heed the following may result in damage to equipment.

- Failure to winterize heat pump may result in serious equipment damage. Freeze damage is not covered under the heat pump warranty.
- While the plumbing connections are in the winterized condition (not fully tightened), it is imperative that water not run through the heat pump. Loss of water through loose plumbing connections may result in damage to circulation pump, pool and spa structures, and other equipment.

### Light Freeze Conditions

A light freeze is when the ambient air temperature falls below 32 degrees Fahrenheit (0° C) for less than 8 hours. Typically during light freeze conditions circulating (or moving) water will not freeze. Temporarily activate the filter pump for continuous operation during light freeze conditions. If the heat pump is directly controlling a water circulation pump, any groups marked as requiring freeze protection will automatically have water circulated to the equipment. See "*Freeze Protection*" on page 35.

### Hard Freeze Conditions

A hard freeze is when the ambient air temperature falls below 32 degrees Fahrenheit (0° C) for more than 8 hours. In areas where this condition is prevalent and sustained, the heat pump **MUST** be winterized for hard freeze conditions. Follow the correct procedure depending on the type of heat exchanger found in the heat pump.

#### ***Confirm Exchanger Type:***

1. Deactivate all electrical power to heat pump.
2. Deactivate the filter pump.
3. Remove the front access panel.
4. Identify heat exchanger from the illustration(s) in this section.
5. Reinstall front access panel. Then follow the procedure for the appropriate heat exchanger.

### Titanium ThermoLink<sup>®</sup> Exchanger (with no Drain)

6. Disconnect the plumbing to the heat pump at connection unions (removal is counter-clockwise).
7. Allow water to drain completely from the heat pump. Expect to see a lot of water drain out at first, and then a small amount to continue to drain out over a long period.
8. After heat pump has fully drained, partially reconnect plumbing connection unions.
9. Winterizing is complete.
10. When ready to use the heat pump again, hand-tighten connection unions. Reconnect electrical power, and set the operating mode on the heat pump. Activate the filter pump.

**No Drain**

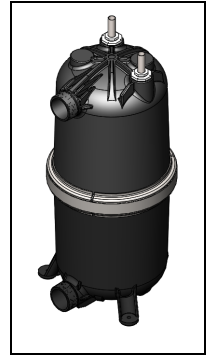

### Titanium ThermoLink<sup>®</sup> Exchanger (with no Drain)

6. Disconnect the plumbing to the heat pump at connection unions (removal is counter-clockwise).
7. Allow water to drain completely from the heat pump. Expect to see a lot of water drain out at first, and then a small amount to continue to drain out over a long period.
8. After heat pump has fully drained, partially reconnect plumbing connection unions.
9. Winterizing is complete.
10. When ready to use the heat pump again, hand-tighten connection unions. Reconnect electrical power, and set the operating mode on the heat pump. Activate the filter pump.

**No Drain**



## Titanium Tube-in-Tube Exchanger

**Titanium  
Tube-in-  
Tube**

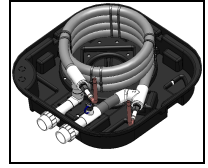

6. Disconnect the plumbing to the heat pump at connection unions (removal is counter-clockwise).
7. Allow water to drain completely from the heat pump. Expect to see a lot of water drain out at first, and then a small amount to continue to drain out over a long period.

8. Place an air hose into the water inlet of the heat pump; wrap a clean rag around the hose to form a temporary seal.
9. Push all water from the water circuit using compressed air no stronger than 50 psig (446 kPa). The residual water should be forced out of the heat pump's water outlet. Allow compressed air to blow into the heat pump inlet for at least 15-20 seconds after the water stops coming out.

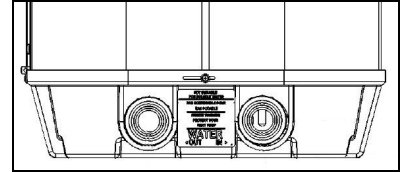

10. Repeat process on the outlet side of the heat pump.
11. Partially reconnect plumbing connection unions.
12. Winterizing is complete.
13. When ready to use the heat pump again, hand-tighten connection unions. Reconnect electrical power, and set the operating mode on the heat pump. Activate the filter pump.

### IN THIS SECTION:

3.1 Adjusting Water Flow Using $\Delta T$ (Delta-T)	41
3.2 Available Accessories	43
3.3 Clearances	45
3.4 Configure Variable Speed Compressors (Select Units)	46
3.5 Identifying Model Specifications	48
3.6 Menu Trees	50
3.7 Initial Heating Recommendations	53
3.8 Initial Cooling Recommendations	54
3.9 Service Mode	54
3.10 Viewing System Information	55

### 3.1 Adjusting Water Flow Using $\Delta T$ (Delta-T)

The Delta-T is the temperature difference between the water temperatures entering and leaving the heat pump. The equipment can be fine-tuned for maximum performance by balancing water flow rates to maintain an ideal  $\Delta T$ .

**The adjustment procedure must be completed with the unit in heating mode.**

- Installed temperature ports are required to perform the following procedures.
- These ports are typically located on the pool in and pool out water lines approximately six inches away from the heat pump.

#### **PLEASE NOTE -**

- The installation of temperature ports is required for all commercial applications.
- The installation of temperature ports is strongly recommended for residential installations.
  - See "*Temperature Port Kit (# STK0096)*" on page 45.

1. Adjust the thermostat to its lowest setting with the unit in heating mode.
2. Deactivate the water filtration pump.
3. Confirm that the filters leading to the heat pump are clean.
4. Adjust the valves controlling water headed towards the heat pump to the half-open position.
5. Adjust the valves controlling water leading away from the heat pump to a fully open position.
6. Activate the pool water filtration pump.
7. Slowly raise the thermostat temperature until the heat pump activates.
  - After a four-minute delay, the heat pump's compressor will start.
8. With the heat pump running, confirm the filtration pump is operating properly with adequate flow and no short cycling.
9. Wait for water temperatures to stabilize (approximately 5 minutes).

**Temperature Port  
(Shown with Probe)**

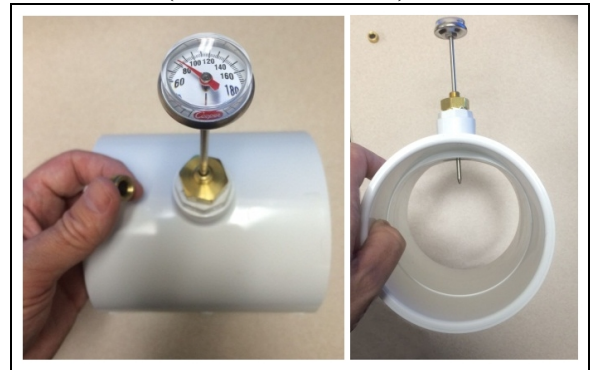

10. Adjust valves in the following order using the temperature chart provided.
- Adjust the valve that controls water exiting the heat pump until the correct temperature differential is achieved. Match the temperature measured with a temperature probe to the chart.
  - Wait for water temperatures to stabilize. Then check the temperature again. Re-adjust the valve as needed.
11. Mark valves at these positions for future reference.

HEAT EXCHANGER TYPE	MODEL	TEMPERATURE
Titanium ThermoLink <sup>®</sup>	SQ120R	3° to 7° F (1.7° C to 3.9° C)
Titanium ThermoLink <sup>®</sup>	SQ125	3° to 7° F (1.7° C to 3.9° C)
Titanium ThermoLink <sup>®</sup>	SQ145	3° to 7° F (1.7° C to 3.9° C)
Titanium ThermoLink <sup>®</sup>	SQ150VS	3° to 7° F (1.7° C to 3.9° C)
Titanium ThermoLink <sup>®</sup>	SQ166R	3° to 8° F (1.7° C to 4.4° C)
Titanium ThermoLink <sup>®</sup>	SQ225	4° to 9° F (2.2° C to 5° C)
Tube-in-Tube	T035	1° to 4° F (.5° C to 2.2° C)
Tube-in-Tube	T055	2° to 5° F (1.1° C to 2.8° C)
Tube-in-Tube	T075	3° to 7° F (1.7° C to 3.9° C)
Titanium ThermoLink <sup>®</sup>	T090	3° to 6° F (1.7° C to 3.3° C)
Titanium ThermoLink <sup>®</sup>	T115	3° to 7° F (1.7° C to 3.9° C)
Titanium ThermoLink <sup>®</sup>	T135	4° to 8° F (2.2° C to 4.4° C)
Titanium Tube-in-Tube	T170	3° to 7° F (1.7° C to 3.9° C)
Titanium Tube-in-Tube	TC500	2° to 5° F (1.1° C to 2.8° C)
Titanium ThermoLink <sup>®</sup>	TC1000	2° to 5° F (1.1° C to 2.8° C)
Titanium ThermoLink <sup>®</sup>	TC1500	3° to 7° F (1.7° C to 3.9° C)

Table 3 - Temperature Chart

**PLEASE NOTE -**

- Temperature differences are based on pool water temperatures of 69° to 75° F. (20.5° to 23.8° C)
- For water temperatures outside this range, contact AquaCal®. See "*Contacting AquaCal AutoPilot, Inc.*" on page 1.

**3.2 Available Accessories**

Accessories may be purchased through an authorized dealer of AquaCal® products.

**Bypass Valve Kit (# STK0135)**

- When high flow rates are outside recommended specifications, please use this kit or an alternative bypass valve system.
- This kit can be used to control excessive water flow through the heat pump. It provides automatic flow adjustments for most applications.



**Condensation Drain Kit (# STK0202)**

- Used when condensation water flow must be directed to a specific location.



**Expansion Board Upgrade Kit (# STK0247)**

- This kit contains an upgrade board that will give the heat pump direct control of actuators, circulation pumps, and relay-controlled devices.



**Spa Turbo Boost Flow Switch Kit (# STK0244)**

- This kit is used to allow for rapid heating of a Spa when a variable speed heat pump is controlled by certain Automation Systems.

### Grid Flow Switch (# 0040S)

- Used for automatic pool/spa thermostat switching.
- This kit is not to be used on applications exceeding 50 PSI (345 kPa).



### Liquid Blankets

- An invisible liquid heat barrier designed to retain heat and extend the swimming season.
- AquaCal® recommends [Lo-Chlor](#)® Aqua Blanket™.



### Over Temperature Alarm Kit

- This kit is an additional safety device. It disables the heat pump if any malfunction occurs that allows the water temperature to surpass a safe level.
- This kit is strongly recommended for all spa applications.
  - Single Phase Heat Pump - (# STK0221)
  - Three Phase Heat Pump - (# STK0222)

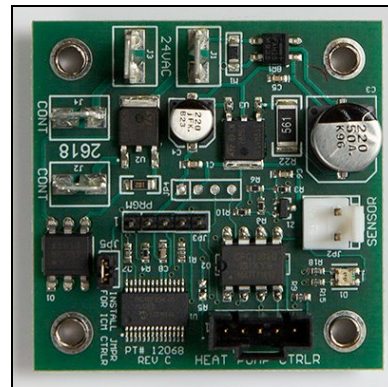

### Plumbing Unions

- 2 Inch Unions - (# PLS2627)





### PoolSync® WI-FI Controller (ECP0343)

- This kit will add WiFi control capabilities to the heat pump.
- Contact installing dealer to order this product.



### Temperature Port Kit (# STK0096)

- This port can be used to adjust water flow using Delta-T.
- The kit comes with port, installation components, and a temperature probe.



### 3.3 Clearances

- Proper air circulation is required for the heat pump to operate efficiently. The following diagrams show the minimum clearances required for the proper operation of the heat pump.
- Avoid placing objects near or on top of the heat pump. This includes shrubbery and lawn furniture. These objects will reduce performance and efficiency and hinder maintenance access.

(Overhead Clearance)

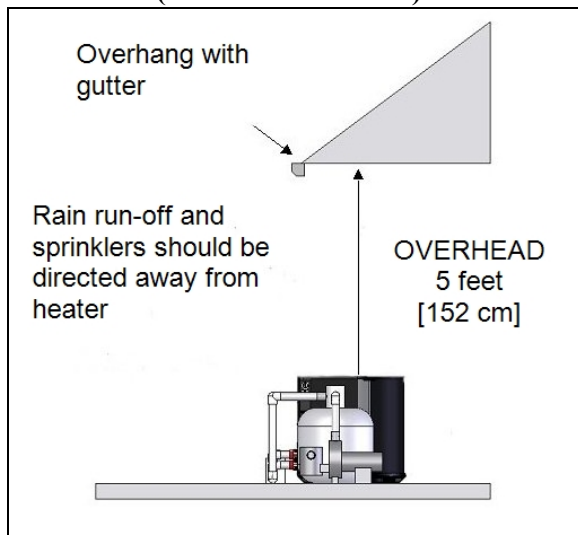

(Top View)

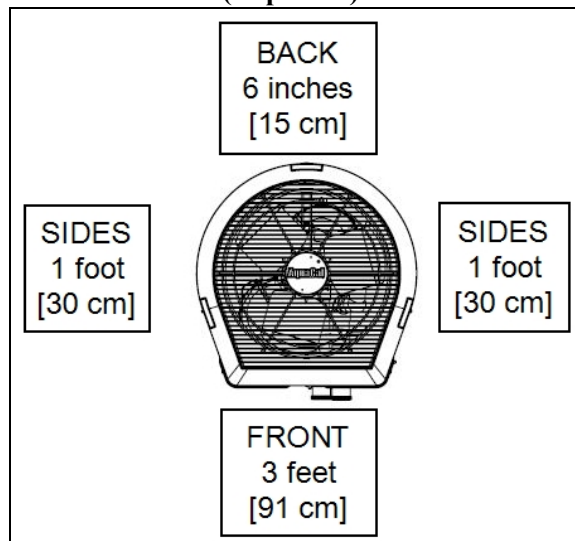

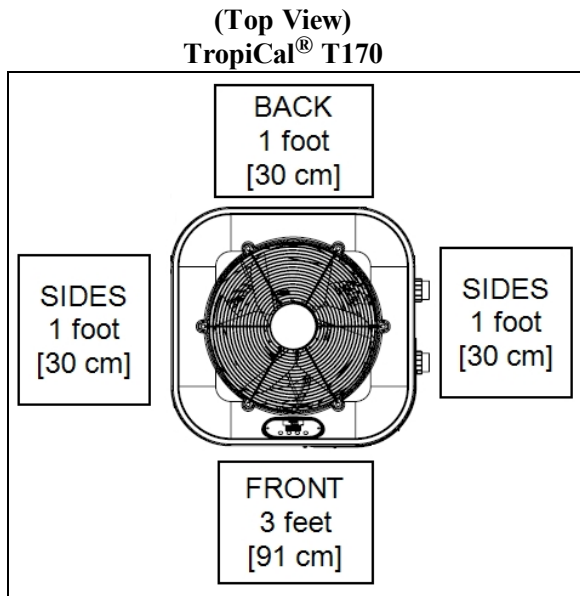

### 3.4 Configure Variable Speed Compressors (Select Units)

Selected heat pumps have variable speed compressors designed to more quickly and efficiently reach a temperature set point. The compressor's performance can be controlled using a turbo boost mode (in the shortcuts menus) or two different types of efficiency modes.

#### Turbo Boost

Upon demand, the heat pump's compressor can be set to maximum speed to heat or cool the water quickly. This is regardless of any previously set efficiency mode settings.

- The system will heat or cool the water with the compressor speed set to maximum. This will continue until the set temperature is reached. Then the configured efficiency mode (scheduled or 24-hour) will resume.
- See "*Turbo Boost*" on the facing page.

#### Efficiency Mode - 24 Hour

When using this mode, the compressor increases to a higher rate of speed until the temperature set point is reached.

- The compressor speed will then lower to maintain that temperature set point. This will continue as long as there is water flow.
- See "*Set Efficiency Mode to 24 Hour*" on the facing page.







#### Efficiency Mode - Filtration Schedule

When using this mode, the compressor's speed is set to heat or cool the water within 60% of the circulation pump's filtration time period. This is the highest efficiency operational mode, providing the lowest cost of operation.

- Example - If the filtration period is set from 10:00 am to 8:00 pm, the system attempts to bring the water to set point by 4:00 pm at optimal performance.
- See "*Set Efficiency Mode to Filtration Schedule*" on page 48.

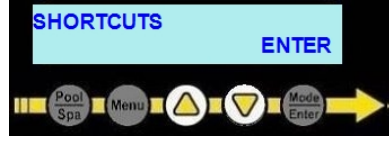

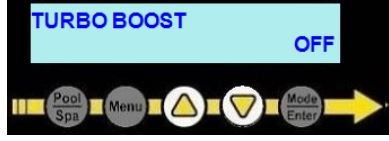

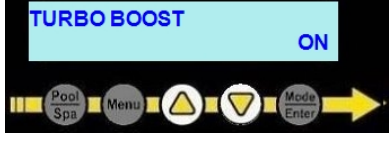
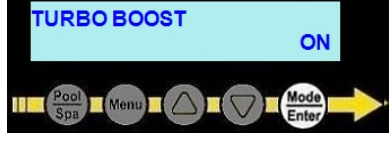
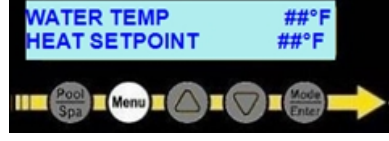

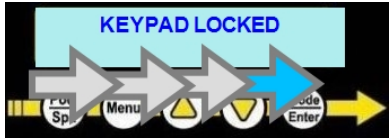

## Turbo Boost

Enter "Shortcuts" menus, then proceed

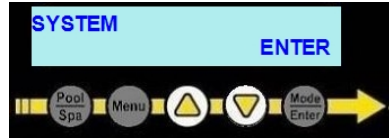
<p><b>IF UNIT IS ASLEEP, SWIPE TO WAKE UP</b></p> 	<p><b>A PRESS MENU BUTTON</b></p> 	<p><b>B USE ARROWS TO "SHORTCUTS"</b></p> 
<p><b>C PRESS "ENTER"</b></p> 	<p><b>1 USE ARROWS TO MENU "TURBO BOOST"</b></p> 	<p><b>2 ENTER TO EDIT</b></p> 
<p><b>3 USE ARROWS TO CHANGE</b></p> 	<p><b>4 ENTER TO SAVE</b></p> 	<p><b>MENU TO EXIT, PRESS &amp; HOLD TO STATUS</b></p> 

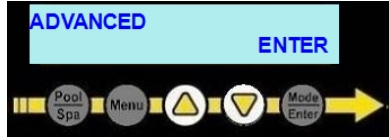
## Set Efficiency Mode to 24 Hour

Enter "Advanced" menus, then proceed

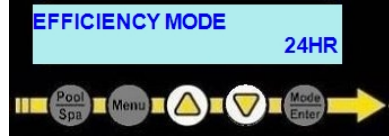
<p><b>IF UNIT IS ASLEEP, SWIPE TO WAKE UP</b></p> 	<p><b>A PRESS MENU BUTTON</b></p> 	<p><b>B USE ARROWS TO "SYSTEM"</b></p> 
<p><b>C PRESS "ENTER"</b></p> 	<p><b>D USE ARROWS TO "ADVANCED"</b></p> 	<p><b>E PRESS "ENTER"</b></p> 
<p><b>1 USE ARROWS TO MENU "EFFICIENCY MODE"</b></p> 	<p><b>2 ENTER TO EDIT</b></p> 	<p><b>3 USE ARROWS TO CHANGE TO "24HR"</b></p> 

**4** ENTER TO SAVE

MENU TO EXIT, PRESS & HOLD TO STATUS

**Set Efficiency Mode to Filtration Schedule**

Enter "Advanced" menus, then proceed

IF UNIT IS ASLEEP, SWIPE TO WAKE UP

**A** PRESS MENU BUTTON

**B** USE ARROWS TO "SYSTEM"

**C** PRESS "ENTER"

**D** USE ARROWS TO "ADVANCED"

**E** PRESS "ENTER"

**1** USE ARROWS TO MENU "EFFICIENCY MODE"

**2** ENTER TO EDIT

**3** USE ARROWS TO CHANGE TO "FILTRATION"

**4** ENTER TO SAVE

MENU TO EXIT, PRESS & HOLD TO STATUS

**3.5 Identifying Model Specifications**

1. Find Data Plate - The data plate is usually posted on the side of the equipment or the inside of the heat pump's access plate.
2. Find the model number on the data plate. The first letters and numbers indicate the model type.
3. The complete model number identifies the equipment's specifications.

### Data Plate Example

MINIMUM CIRCUIT AMPACITY	<input type="text"/>	MADE IN THE USA
ELEC. SERVICE: VOLTS	<input type="text"/>	PH <input type="text"/> HZ <input type="text"/>
MAXIMUM TIME DELAY FUSE OR HACR BREAKER <input type="text"/> 5		
COMPRESSOR VOLTS	R.L.A. <input type="text"/>	L.R.A. <input type="text"/>
FAN MOTOR VOLTS	H.P. <input type="text"/>	F.L.A. <input type="text"/>
REFRIGERANT: Circuit - Factory charged <input type="checkbox"/> Only oz/Kg <input type="text"/>		
Tested to <input type="text"/> psig High side / <input type="text"/> psig Low side		
OUTDOOR UNIT		
AQUA CAL, INC A TEAM HORNER COMPANY 2737 24 <sup>TH</sup> STREET NORTH ST. PETERSBURG, FL 33713 FACTORY SERVICE 727-523-5642	MODEL NUMBER	<input type="text"/>
	<b>IIIBAR CODE III</b>	
	SERIAL NUMBER	<input type="text"/>
	<b>IIIBAR CODE III</b>	

### Model Number Example

MODEL NUMBER NOMENCLATURE											
SQ	225	A	R	V	S	B	N	N			
Brand Designation		Unit Designation		Voltage Designation (Voltage / Hertz / Phase) A = 208-230/60/1 B = 208-230/60/3 D = 380-415/50/3 E = 380-420/60/3 G = 460/60/3 H = 200-220/50/1 N = Nil		Features C = Chill Only H = Heat Only R = Heat and Cool S = Split Chiller T = Split Heater		Controls D = Digital      V = Variable A = Analog      Speed N = None          Compressor		Refrigerant S = R410A T = R407C E = R22	
						Water Coil Designation C = Cupronickel D = Demo Unit H = High Pressure Cupronickel L = Tube-in-tube M = Packaging for Mexico N = No Options P = ThermoLink® II (5/8 for 2016) R = ThermoLink® II (3/4 and 5/8) T = ThermoLink® II X = None		Color Designation A = Black outside cabinet / White inside cabinet B = Black W = White C = Creme T = Taupe		Unit Revision A THROUGH Z AA THROUGH ZZ AAA THROUGH ZZZ	

UPDATED  
07/14/2016

### 3.6 Menu Trees

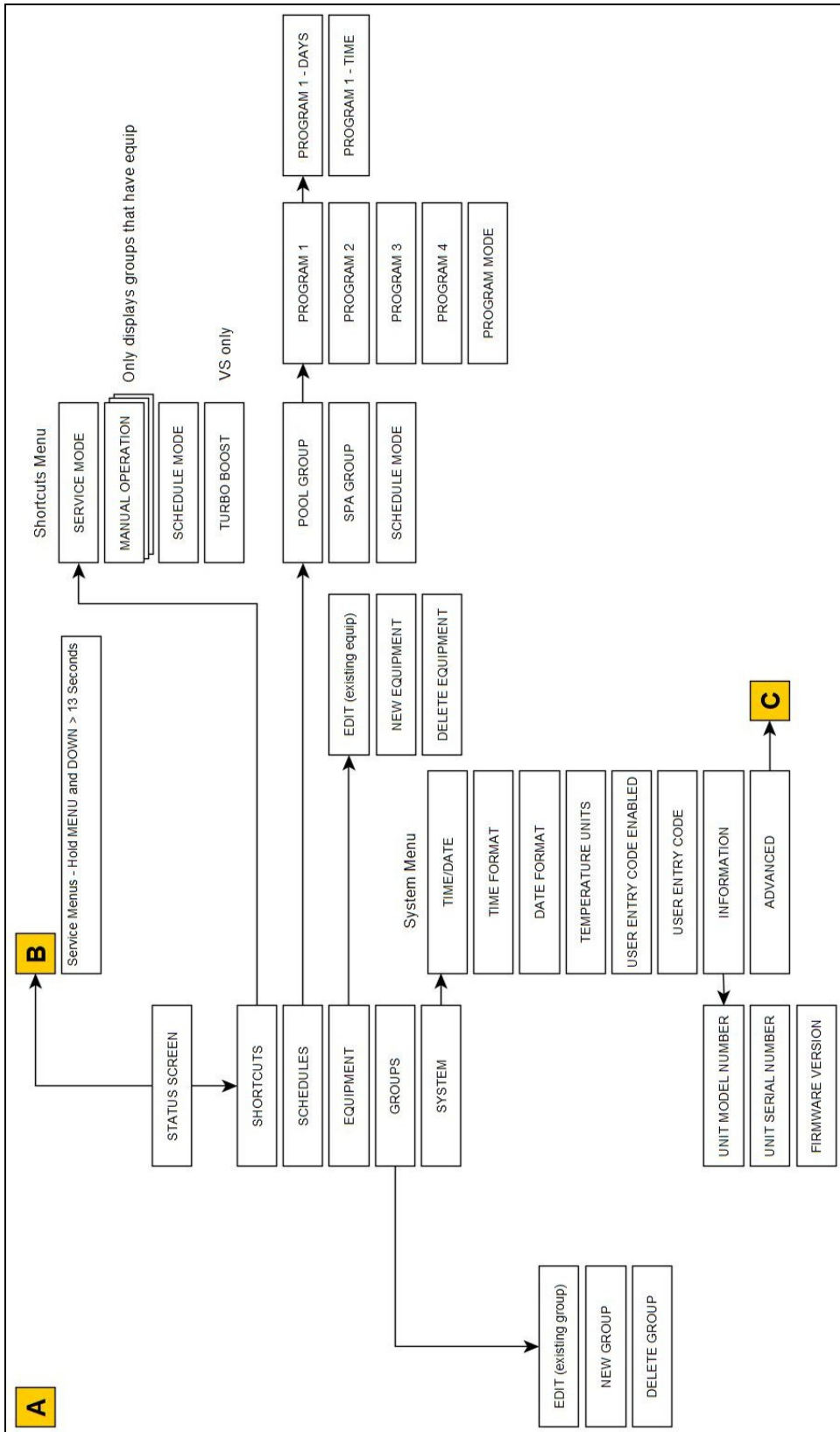

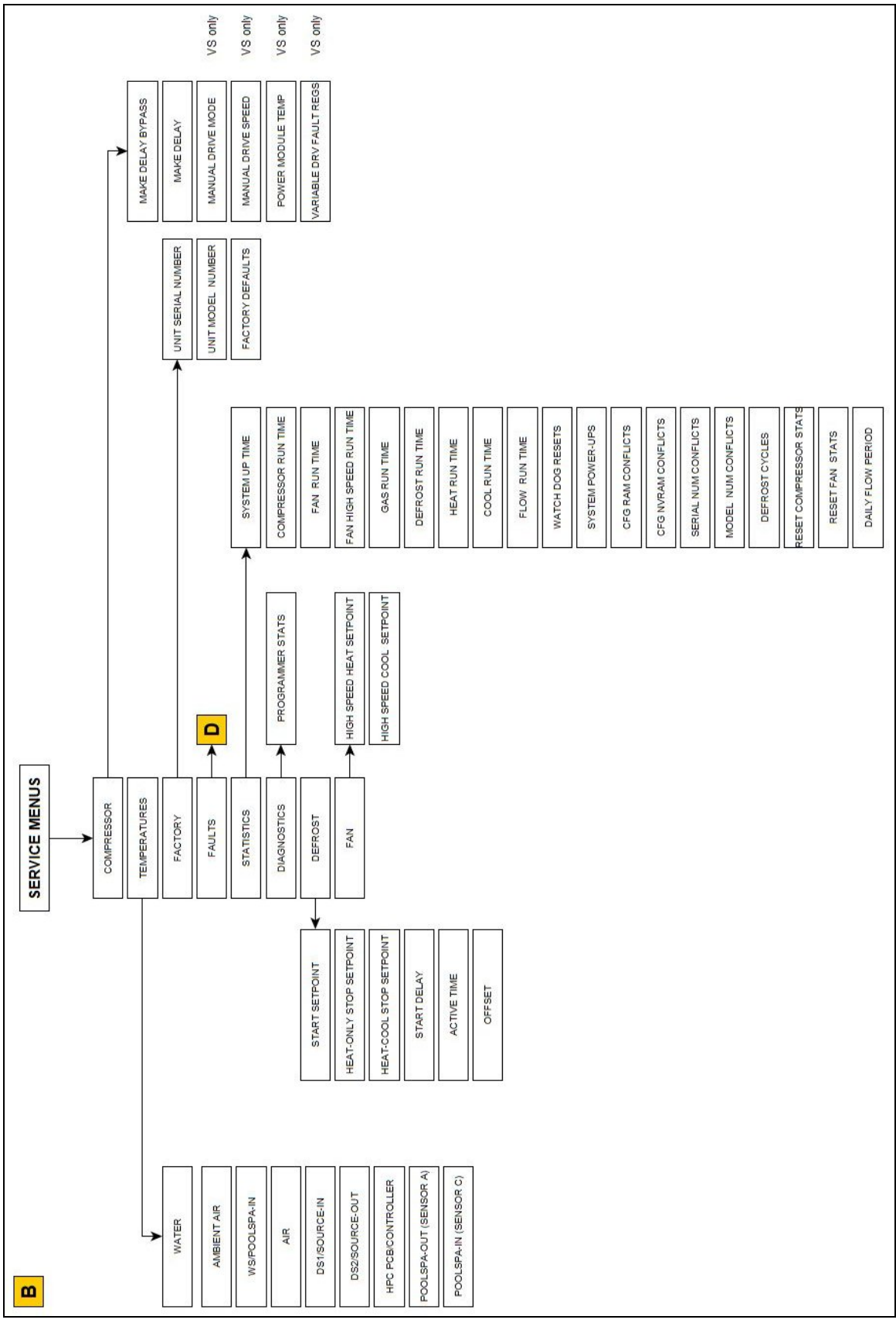

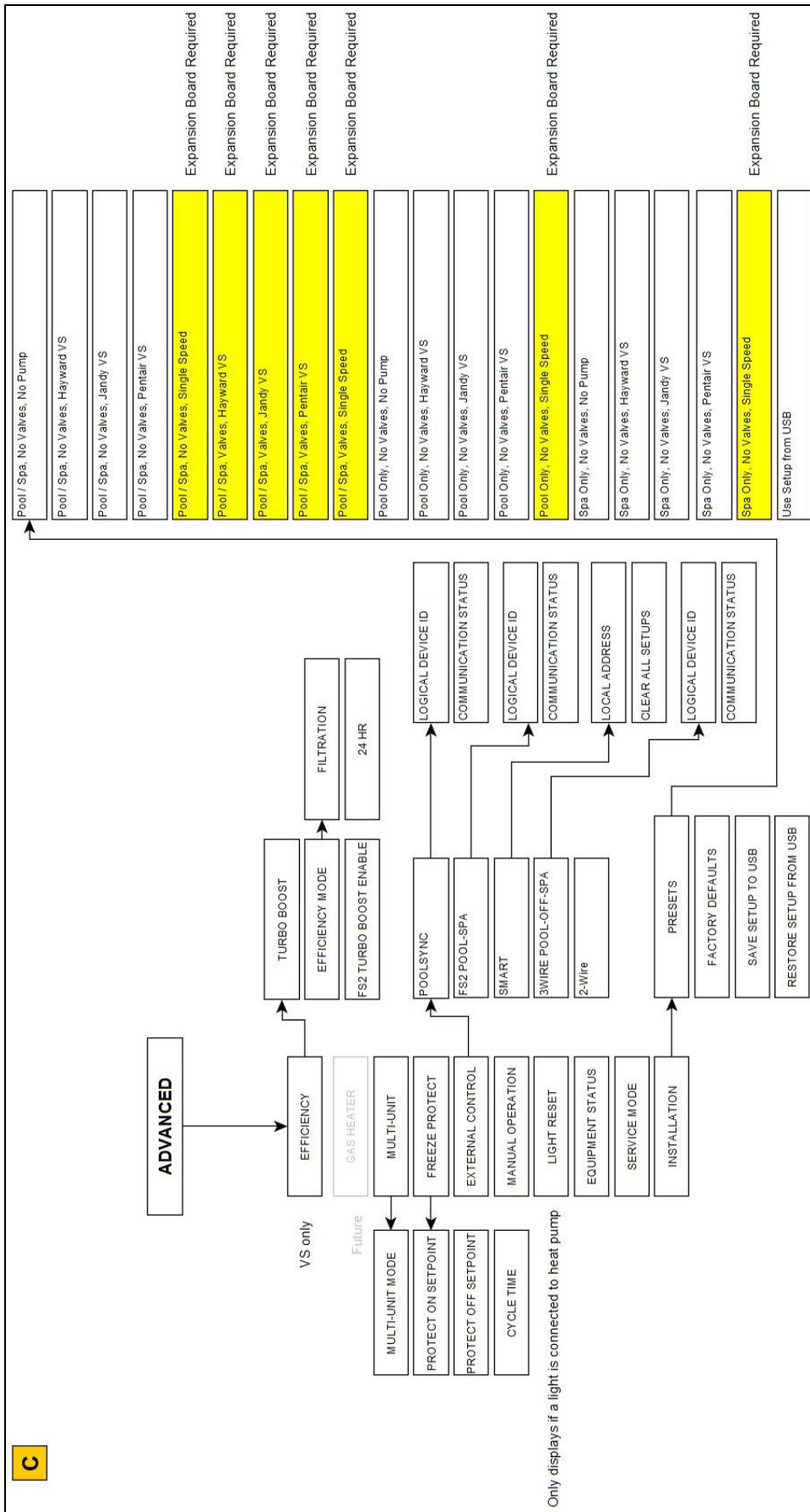



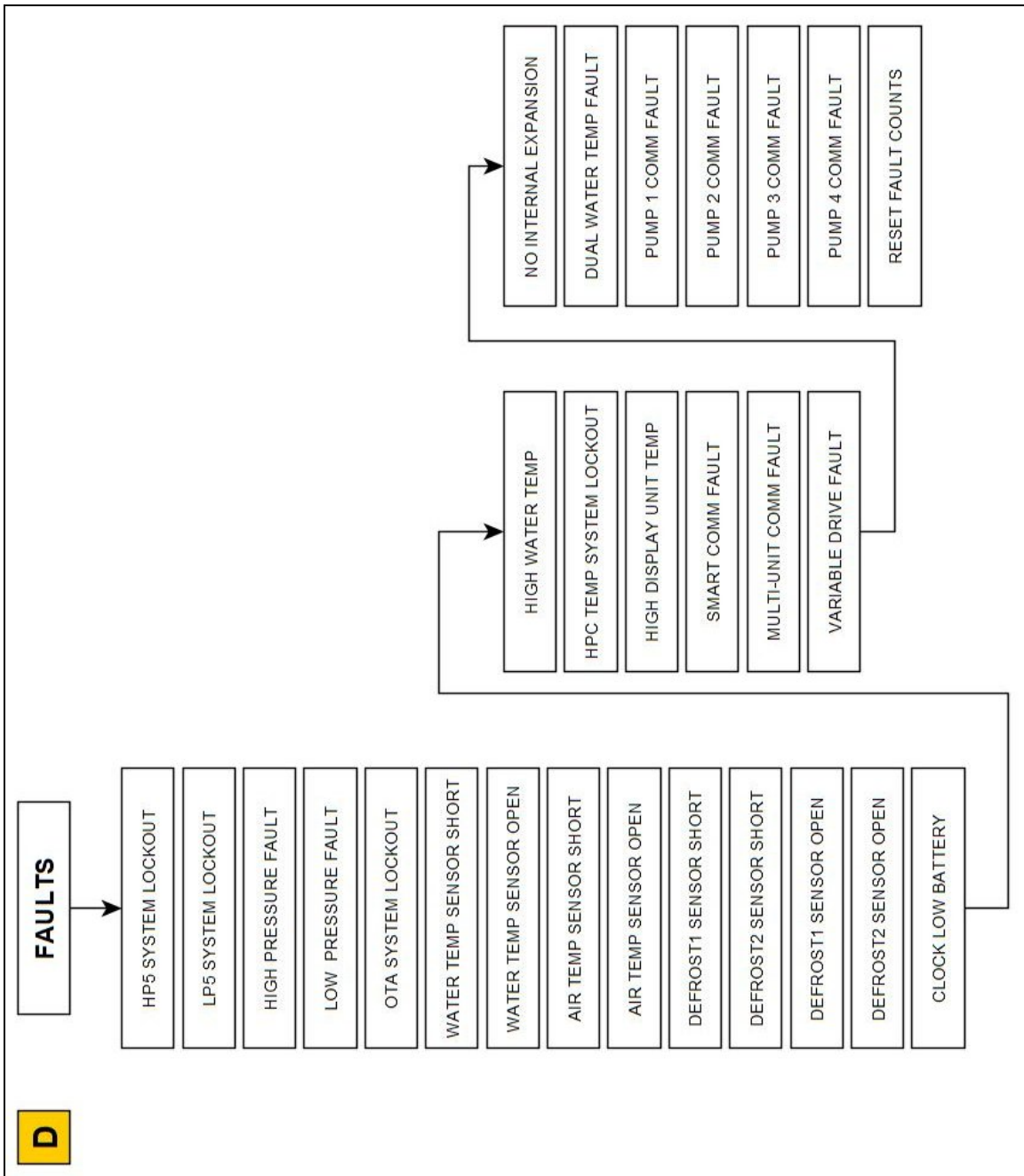

### 3.7 Initial Heating Recommendations

The following recommendations will reduce the amount of time required to heat a pool. **If unsure of equipment heating capability, review equipment data plate.** See "*Identifying Model Specifications*" on page 48.

1. Use the heat pump's "POOL/SPA" button to select the "POOL" group.
2. Select 48HR (48 hours) for the "SET TIME".
3. Confirm the mode has been set to "HEAT" mode.
4. Set the desired temperature "HEAT SETPOINT" for the water.
5. If a circulation pump has been connected to the heat pump, it will automatically activate.
6. Activate Turbo Boost Mode if equipped.
7. Use a pool cover or blanket to reduce heating time.

### 3.8 Initial Cooling Recommendations









The following recommendations will reduce the amount of time required to cool a pool or cold plunge application. **If unsure of equipment cooling capability, review equipment data plate.** See "*Identifying Model Specifications*" on page 48.

1. Use the heat pump's "POOL/SPA" button to select the "POOL" group.
2. Select 48HR (48 hours) for the "SET TIME".
3. Confirm the mode has been set to "COOL" mode.
4. Set the desired temperature "COOL SETPOINT" for the water.
5. If a circulation pump has been connected to the heat pump, it will automatically activate.
6. Activate Turbo Boost Mode if equipped.

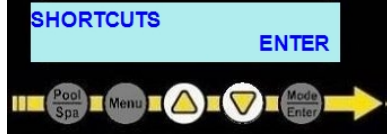
### 3.9 Service Mode

The heat pump can be set into a service mode where all connected devices including the heat pump can be deactivated for servicing. While in service mode, connected devices / equipment can be manually activated as needed.

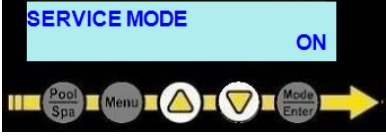
Enter "Shortcuts" menus, then proceed

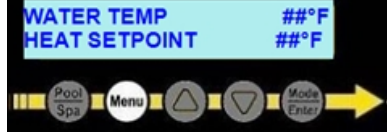
<p><b>IF UNIT IS ASLEEP, SWIPE TO WAKE UP</b></p> 	<p><b>A PRESS MENU BUTTON</b></p> 	<p><b>B USE ARROWS TO "SHORTCUTS"</b></p> 
<p><b>C PRESS "ENTER"</b></p> 	<p><b>1 USE ARROWS TO MENU "SERVICE MODE"</b></p> 	<p><b>2 PRESS ENTER TO EDIT</b></p> 
<p><b>3 USE ARROWS TO "ON"</b></p> 	<p><b>4 ENTER TO SAVE</b></p> 	<p><b>MENU TO EXIT, PRESS &amp; HOLD TO STATUS</b></p> 

When service is complete, repeat above steps setting SERVICE MODE to "OFF".

### 3.10 Viewing System Information

The heat pump model, serial number, and firmware version can be viewed in the information menus.

Enter "System" menus, then proceed

**IF UNIT IS ASLEEP, SWIPE TO WAKE UP**

KEYPAD LOCKED

**A PRESS MENU BUTTON**

WATER TEMP ##°F  
HEAT SETPOINT ##°F

**B USE ARROWS TO "SYSTEM"**

SYSTEM ENTER

**C PRESS "ENTER"**

SYSTEM ENTER

**1 USE ARROWS TO MENU "INFORMATION"**

INFORMATION ENTER

**2 PRESS ENTER TO VIEW**

INFORMATION ENTER

**3 USE ARROWS TO VIEW "UNIT SERIAL NUMBER"**

UNIT SERIAL NUMBER  
XXXXXXXXXX

**4 USE ARROWS TO VIEW "UNIT MODEL NUMBER"**

UNIT MODEL NUMBER  
XXXXXXXXXX

**5 USE ARROWS TO VIEW "FIRMWARE VERSION"**

FIRMWARE VERSION  
HPC XXXXX DISP XXXXX

**MENU TO EXIT, PRESS & HOLD TO STATUS**

WATER TEMP ##°F  
HEAT SETPOINT ##°F

**IN THIS SECTION:**

**Fault Codes**

AIR TEMP SENSOR OPEN or AIR TEMP SENSOR SHORT .....	57
CLOCK LOW BATTERY .....	57
DEFROST1 SENSOR OPEN or DEFROST2 SENSOR OPEN .....	58
DEFROST1 SENSOR SHORT or DEFROST2 SENSOR SHORT .....	58
ERROR AT PRIMARY UNIT .....	58
HIGH PRESSURE FAULT .....	58
HIGH WATER TEMP .....	58
HP5 SYSTEM LOCKOUT .....	59
HPC TEMP SYSTEM LOCKOUT .....	59
LOW PRESSURE FAULT .....	60
LP5 SYSTEM LOCKOUT .....	60
MULTI-UNIT COMM FAULT .....	61
SMART COMM FAULT .....	61
VARIABLE DRIVE FAULT .....	61
WATER PUMP COMM FAULT .....	61
WATER TEMP SENSOR SHORT or WATER TEMP SENSOR OPEN .....	61

**Issues and resolutions**

Blank Display .....	62
Circulation Pump Won't Activate .....	62
Display Panel Not Responding .....	63
Displays "DEFROSTING" .....	63
Displays "FREEZE PROTECTION ACTIVE" .....	63
Displays "NO SYSTEM FIRMWARE" .....	63
Displays "NO POOL/SPA WATER FLOW" .....	64
Displays "SET TO SWITCH REMOTELY" .....	64
Displays "UNIT MODEL NUMBER" .....	64
Heat Pump Not Running .....	65
Heat Pump's Tripping Breaker .....	65
Heat Pump Won't Shut Off .....	65
Heat Pump Is Running, Not Heating .....	66
Heat Pump Is Running, Not Cooling .....	67
Ice Forming on the Heat Pump .....	67
"Pool / Spa" Button Isn't Working .....	68
Schedule Not Working .....	68
Water Coming From Heat Pump .....	68

## 4.1 Fault Codes

A fault code indicates a specific issue or condition that will require action before the equipment can resume operating.

Please perform the following troubleshooting.

If the issue reoccurs, please contact AquaCal. See "*Contacting AquaCal AutoPilot, Inc.*" on page 1.

### DANGER

Failure to heed the following will result in injury or death.

- Deactivate power while routing wiring to control board.
- RISK OF ELECTRICAL SHOCK FROM ENERGY STORED IN CAPACITORS - MODELS EQUIPPED WITH VARIABLE FREQUENCY COMPRESSOR DRIVES STORE ELECTRICITY EVEN AFTER THE POWER HAS BEEN DEACTIVATED AT THE POWER BREAKER. ***Wait for 2 minutes after the shut down of equipment before servicing.***
- Follow all National Electric Codes (NEC) and/or State and Local guidelines.

### WARNING

Failure to heed the following may result in injury or death.

- Repairs must not be attempted by untrained or unqualified individuals.
- The heat pump contains refrigerant under high pressure. Repairs to the refrigerant circuit must not be attempted by untrained or unqualified individuals. Service must be performed only by qualified HVAC technicians. Recover refrigerant before opening the system.

### NOTICE

Failure to heed the following may result in damage to equipment.

- Service by unauthorized personnel will void the heat pump warranty.

## AIR TEMP SENSOR OPEN or AIR TEMP SENSOR SHORT

### ISSUE

Open or shorted air sensor.

### RESOLUTION

- A qualified technician should confirm sensor is properly connected.
- A qualified technician should consider replacing the air sensor as needed.
- A power reset after resolving sensor issues is required.

## CLOCK LOW BATTERY

### ISSUE

The real-time clock controller indicates a low battery condition.

- The time will reset to factory default.

### RESOLUTION

A qualified technician should replace the battery. The date and time will need to be reset on the heat pump after replacement.

**DEFROST1 SENSOR OPEN or DEFROST2 SENSOR OPEN****ISSUE**

Open defrost sensor.

**RESOLUTION**

A qualified technician should replace the defrost sensor.

**DEFROST1 SENSOR SHORT or DEFROST2 SENSOR SHORT****ISSUE**

Shorted defrost sensor.

**RESOLUTION**

A qualified technician should replace the defrost sensor.

**ERROR AT PRIMARY UNIT****ISSUE**

The heat pump is secondary to a primary heat pump that is displaying a fault code.

**RESOLUTION**

The error at the primary heat pump must be corrected before the secondary unit will resume operation.

**HIGH PRESSURE FAULT****ISSUE**

The refrigerant system's high-pressure switch is showing as open.

**RESOLUTION****Heat and Cool Units (Reversing)**

Place heat pump in heating mode and perform the following troubleshooting.

Determine if an insufficient amount of water is being supplied to the equipment.

1. Confirm the filter pump is on.
2. If a multiple-speed filter pump is being used, run filter pump at a higher speed. Do not exceed the maximum flow rate for the model.
3. Confirm water is not being diverted away from the heat pump.
  - See "*Water Flow Rates*" on page 33.
  - See "*Adjusting Water Flow Using  $\Delta T$  (Delta-T)*" on page 41.

**HIGH WATER TEMP****ISSUE**

Incoming water temperature has exceeded 108° F (42° C) and the unit has been deactivated. The heat pump will not operate until the incoming water temperature drops to 100° F (38° C) or lower.

**RESOLUTION**

1. Determine if a gas heater is sending water directly to the heat pump. This situation would need to be corrected before continuing.
2. If the **HIGH WATER TEMP** fault continues to display, the water temperature sensor may require replacement.

## HP5 SYSTEM LOCKOUT

### ISSUE

The heat pump has locked due to five high-pressure faults during one call for heating or cooling.

### RESOLUTION

1. Deactivate then reactivate power to the heat pump to clear error.
2. Troubleshoot the high-pressure issue causing the error.
  - See "*HIGH PRESSURE FAULT*" on the previous page.

## HPC TEMP SYSTEM LOCKOUT

### ISSUE

The heat pump's controller board is overheating.

### RESOLUTION

A qualified technician should be contacted to correct the issue.

## LOW PRESSURE FAULT

### ISSUE

The refrigerant system's low-pressure switch is showing as open.

### RESOLUTION

#### Heat Only Units

Place heat pump in heating mode and perform the following troubleshooting.

1. Check for proper fan operation. If the fan is not operating, contact AquaCal® Technical Support.
2. Check for obstructed airflow around the heat pump.
  - See "*Clearances*" on page 45.
3. Check for a dirty or blocked evaporator coil.
  - See "*Cleaning Equipment*" on page 31.
4. Check for signs of heavy ice buildup on the coil.

#### Cool Only Units

Place heat pump in heating mode and perform the following troubleshooting.

Determine if an insufficient amount of water is being supplied to the equipment.

1. Confirm the filter pump is on.
2. If a multiple-speed filter pump is being used, run filter pump at a higher speed. Do not exceed the maximum flow rate for the model.
3. Confirm water is not being diverted away from the heat pump.
  - See "*Water Flow Rates*" on page 33.
  - See "*Adjusting Water Flow Using  $\Delta T$  (Delta-T)*" on page 41.

#### Heat and Cool Units (Reversing)

Place heat pump in heating mode and perform the following troubleshooting.

1. Check for proper fan operation. If the fan is not operating, call for service.
2. Check for obstructed airflow around the heat pump.
  - See "*Clearances*" on page 45.
3. Check for a dirty or blocked evaporator coil.
  - See "*Cleaning Equipment*" on page 31.
4. Check for signs of heavy ice buildup on the coil.

## LP5 SYSTEM LOCKOUT

### ISSUE

The heat pump has locked due to five low-pressure faults during one call for heating or cooling.

### RESOLUTION

1. Deactivate then reactivate power to the heat pump to clear error.
2. Troubleshoot the low-pressure issue causing the error.
  - See "*LOW PRESSURE FAULT*" above.



**MULTI-UNIT COMM FAULT****ISSUE**

Secondary heat pump is not receiving a signal from the primary heat pump.

**RESOLUTION**

1. Confirm the primary heat pump is operating correctly. If, for example, no power is supplied to the primary heat pump, an error will appear on the secondary heat pumps.

**SMART COMM FAULT****ISSUE**

Heat Pump is not receiving a signal from an external controller using a smart connection point.

**RESOLUTION**

1. Confirm a smart external controller is being used.
  - If unsure, contact installer of heat pump for more information. The heat pump may need to be reconfigured to set external controller to "none".
2. If using a smart external controller, confirm the controller is correctly set to send signals to the heat pump. See manuals or guides provided with the external controller.

**VARIABLE DRIVE FAULT****ISSUE**

A problem was detected in the variable speed compressor.

**RESOLUTION**

Deactivate heat pump at power disconnect.

**Wait for two minutes for the capacitors to discharge.**

Then reactivate heat pump's power at disconnect. If error reoccurs, call for service.

**WATER PUMP COMM FAULT****ISSUE**

The heat pump has lost communication with a connected water pump.

**PLEASE NOTE:**

*The name of the water pump will be displayed for this fault. As an example, if the name "CIRCULATION PUMP" was used when configuring the water pump as a piece of equipment in the system, then the fault will display as "CIRCULATION PUMP COMM FAULT".*

**RESOLUTION**

A qualified service technician will need to confirm the water pump is working, properly connected, and configured to the heat pump.

**WATER TEMP SENSOR SHORT or WATER TEMP SENSOR OPEN****ISSUE**

Shorted or open water sensor connected to "W/S" port on main control board.

**RESOLUTION**

A qualified technician should replace the water sensor.

## 4.2 Issues and Resolutions

### DANGER

Failure to heed the following will result in injury or death.

- Deactivate power while routing wiring to control board.
- RISK OF ELECTRICAL SHOCK FROM ENERGY STORED IN CAPACITORS - MODELS EQUIPPED WITH VARIABLE FREQUENCY COMPRESSOR DRIVES STORE ELECTRICITY EVEN AFTER THE POWER HAS BEEN DEACTIVATED AT THE POWER BREAKER. *Wait for 2 minutes after the shut down of equipment before servicing.*
- Follow all National Electric Codes (NEC) and/or State and Local guidelines.

### WARNING

Failure to heed the following may result in injury or death.

- Repairs must not be attempted by untrained or unqualified individuals.
- The heat pump contains refrigerant under pressure. Repairs to the refrigerant circuit must not be attempted by untrained or unqualified individuals. Service must be performed only by qualified HVAC technicians. Recover refrigerant before opening the system.

### NOTICE

Failure to heed the following may result in damage to equipment.

- Service by unauthorized personnel will void the factory warranty.

Please perform the following troubleshooting.

For further assistance, please contact AquaCal. See "*Contacting AquaCal AutoPilot, Inc.*" on page 1.

### Blank Display

#### ISSUE

The Heat Pump may have an incoming power problem.

#### RESOLUTION

Confirm electrical power is being supplied to the heat pump from electrical disconnect(s).

### Circulation Pump Won't Activate

#### ISSUE

A circulation pump controlled by the heat pump will not activate as needed.

#### RESOLUTION

1. Confirm circulation pump is included in any group that requires it. See "*Edit a Group*" on page 17.
2. Confirm the group containing the circulation pump has an appropriate schedule. See "*Edit a Schedule*" on page 20.
3. Confirm the schedule mode is set to "AUTO" and the scheduled program mode is set to "ON". See "*Schedule and Program Modes*" on page 23.

**Display Panel Not Responding****ISSUE**

The heat pump's display panel will not respond to user input.

**RESOLUTION**

1. If heat pump display shows "**UNDER REMOTE CONTROL**", use the external control device to control the heat pump.
2. If needed, check with the external controller manufacturer for further assistance using that device.

**Displays "DEFROSTING"****ISSUE**

The heat pump has sensed the coil is icing up. See "*Ice Forming on the Heat Pump*" on page 67. No action is required.

**RESOLUTION****Heat and Cool Units - Active Defrost**

Hot refrigerant gas will be sent through the coil to rapidly remove ice or frost.

During this process, the melting of the ice may appear as steam coming off the heat pump. This is normal.

**Displays "FREEZE PROTECTION ACTIVE"****ISSUE**

The heat pump has sensed the air temperature has dropped below 37° F (0° C). This is the default setpoint before the heat pump begins to circulate water to groups marked as needing freeze protection. The heat pump will not heat water in these conditions. (See "*Freeze Protection*" on page 35 for more information.)

**NOTICE**

Failure to heed the following may result in damage to equipment.

- Freeze protection is meant to be temporary. If freezing temperatures will continue for an extended time frame, the pool equipment ***must*** be winterized.

**PLEASE NOTE:**

*This protection is only available for heat pumps that directly control a circulation pump.*

**Displays "NO SYSTEM FIRMWARE"****ISSUE**

The heat pump has encountered a software error.

**RESOLUTION**

Call for service.

## Displays "**NO POOL/SPA WATER FLOW**"

### ISSUE

Low or no water detected. This is normal when the circulation pump is deactivated.

### RESOLUTION

1. Confirm the filter pump is on.
2. If a multiple-speed filter pump is being used, run at a higher speed to determine if the error persists. Do not exceed the maximum flow rate for your model.
3. Confirm water is not being diverted away from the heat pump.
  - See "*Water Flow Rates*" on page 33.
  - See "*Adjusting Water Flow Using  $\Delta T$  (Delta-T)*" on page 41.

## Displays "**SET TO SWITCH REMOTELY**"

### ISSUE

If when pressing the "Pool / Spa" button the display flashes the message "**SET TO SWITCH REMOTELY**", the heat pump is using a remote relay switch or a 3-wire controller.

### RESOLUTION

- The Pool and Spa thermostat automatically switch when using these modes.
- Operation manually will not be available when using these external devices. No action is required.

## Displays "**UNIT MODEL NUMBER**"

### ISSUE

The heat pump has encountered a software error.

### RESOLUTION

- The model number and serial number will need to be re-entered into the system. The system will then operate as normal.
- If the issue reoccurs, please contact the distributor or installing dealer.

## Heat Pump Not Running

### ISSUE

The heat pump will not run.

### RESOLUTION

1. Confirm equipment is receiving power. Is the heat pump display illuminated?
  - If not, confirm the main breaker (located at the power supply panel) and the disconnect switch (located near the heat pump) are both turned on.
  - If the display still does not illuminate, it is recommended that the heat pump installer or electrician confirm the heat pump is receiving power.
2. Confirm correct mode is selected.
  - See "*Activate HEAT Mode, COOL Mode, AUTO Mode, or Deactivate Equipment*" on page 7.
3. Confirm thermostat is set correctly.
  - When heating the water is desired, the thermostat should be set above the current water temperature.
  - When cooling the water is desired, the thermostat should be set below the current water temperature.
  - See "*Set a desired temperature (setpoint) for the heat pump to activate*" on page 7.
4. If an error code is displayed, diagnose and correct the cause of the code.
  - See "*Fault Codes*" on page 57.
5. If the heat pump is using an external controller, the heat pump may not be set correctly to accept the controller's signal.
  - See "*Operating Heat Pump (With an External Controller)*" on page 29.

## Heat Pump's Tripping Breaker

### ISSUE

The heat pump breaker(s) keeps tripping.

### RESOLUTION

1. If AquaCal<sup>®</sup> heat pumps have been connected using a multiple heat pump configuration, the configuration may be incorrect. Please confirm settings or contact installer of equipment.
2. Have an electrician confirm breakers are correct type, in good condition, and properly sized for the heat pump.

## Heat Pump Won't Shut Off

### ISSUE

The heat pump will not deactivate.

### RESOLUTION

#### **PLEASE NOTE**

*When the heat pump is set to off, the display will show the current water temperature or no water flow indicator.*

1. Confirm the correct mode has been set on the heat pump.
  - See "*Activate HEAT Mode, COOL Mode, AUTO Mode, or Deactivate Equipment*" on page 7.
2. Confirm the heat pump has reached the desired temperature set on the thermostat. The heat pump will continue to run until the set temperature is reached.
  - See "*Set a desired temperature (setpoint) for the heat pump to activate*" on page 7.
3. If the heat pump is using an external controller, it may not be set correctly. See the external controller's manual.

### ISSUE

The heat pump is running. But the water is not heating.

### RESOLUTION

1. If the heat pump is using an external controller, confirm it is set correctly.
  - See "*Operating Heat Pump (With an External Controller)*" on page 29.
  - If the heat pump is still not running correctly with this device, contact the installer of the device or the device's manufacturer for further assistance.
2. Confirm heat pump mode is set to heat.
3. Confirm thermostat is set to the desired water temperature.
4. Confirm valves are positioned to heat the correct body of water (either the pool or the spa). If heating a spa that overflows into a pool, confirm the spa is isolated when being heated (not flowing into the pool).
5. Confirm heat pump is transferring heat into the water.
  - Measure the temperature of air discharge coming out of the heat pump fan. If discharge air is between 8° to 10° F (4.4° to 5.6° C) colder than the outside ambient air, the heat pump is moving heat into the water.
6. If an error code is displayed, diagnose and correct cause of code.
  - See "*Fault Codes*" on page 57.
7. Confirm that the filter pump has a sufficient run-time. The heat pump will not run (or heat the water) without water flow.
  - See "*Initial Heating Recommendations*" on page 53.
8. If heating a spa, deactivate air blower or venturi (if equipped) to allow for quicker heating times. For pools, deactivate water features, such as slides, waterfalls, or fountains to allow water to retain heat. Use of a liquid pool blanket product, such as an Aqua Blanket™, can also compensate for excessive heat loss.
  - See "*Liquid Blankets*" on page 44.

## Heat Pump Is Running, Not Cooling

### ISSUE

The heat pump is running. But the water is not cooling.

### RESOLUTION

1. If the heat pump is using an external controller, confirm the heat pump is programmed properly to allow for cooling.
  - See "*Operating Heat Pump (With an External Controller)*" on page 29.
2. Confirm the heat pump mode is set to cool.
3. Confirm the thermostat is set below the current water temperature.
4. Confirm valves are positioned to cool the correct body of water (either the pool or the spa). If cooling a spa that overflows into a pool, confirm the spa is isolated when being cooled (not flowing into the pool).
5. If an error code is displayed, determine and correct the condition causing the code.
  - See "*Fault Codes*" on page 57.
6. Confirm heat pump is transferring heat out of the water.
  - Measure the temperature of air discharge coming out of the heat pump's fan. If the air is between 8° to 10° F (4.4° to 5.6° C) warmer than the outside ambient air, the heat pump is moving heat out of the water.
7. Confirm that the filter pump has a sufficient run-time. The heat pump will not run (or cool the water) without water flow.
  - See "*Initial Cooling Recommendations*" on page 54.

## Ice Forming on the Heat Pump

### ISSUE

When conditions are too cold for proper operation, the heat pump will enter a defrost mode. This prevents ice from building up on the evaporator coil.

### RESOLUTION

#### Heat and Cool Units (with Active Defrost or "Icebreaker"):

- During freezing conditions, pool or spa heating will continue. Frost or ice may develop during the "countdown" to the active defrost (up to 50 minutes). This is normal. See "*Displays Defrosting*" on page 63.
- The heat pump will enter an "active defrost" stage to remove the accumulated frost and ice.
  - Be sure to observe the unit for at least 50 minutes. If it has not entered an active defrost cycle, call for service.

#### **TIP:**

*The heat pump can be manually set to defrost by temporarily switching to the cooling mode until the ice or frost melts.*

- If the ambient air temperature is (or will be) falling below 32° F (0° C) for more than 8 hours, winterize equipment.
  - See "*Winterizing*" on page 38.

**"Pool / Spa" Button Isn't Working****ISSUE**

The "Pool / Spa" button is disabled if the following devices have been configured on the heat pump. Check with installer if unsure of devices enabled on heat pump.

- A 2-wire external controller.
- A 3-wire external controller.
- A "SMART" external controller.
- An external flow switch.

**RESOLUTION**

If not used to operate the heat pump, deactivate the external control device.

**Schedule Not Working****ISSUE**

A device isn't operating as scheduled.

**RESOLUTION**

- Confirm the group has an appropriate schedule program. See "*Edit a Schedule*" on page 20.
- Confirm the schedule mode is set to "AUTO" and the scheduled program mode is set to "ON". See "*Schedule and Program Modes*" on page 23.
- Confirm the time is set correctly in the system. See "*Setting Date and Time*" on page 10.

**Water Coming From Heat Pump****ISSUE**

The water may be normal condensation produced as a by-product of the heat pump's refrigeration process.

The heat pump can produce up to 8 to 10 gallons (30 to 38 liters) of condensation per hour depending on the humidity of the ambient air. Determine if the water is condensation or a possible leak.

**RESOLUTION**

1. Deactivate heat pump, leaving the filter pump on. After several hours, determine if the water is still coming from the heat pump.
2. If using chlorine or bromine as a pool/spa sanitizer, test the water around the heat pump using a test strip. If the test strip indicates that chlorine or bromine is present, a leak may exist.

**PLEASE NOTE -**

*If desired, a kit is available to re-direct condensation water away from the heat pump.*

- See "*Condensation Drain Kit (# STK0202)*" on page 43.



