

A Wake up heat pump

The display's backlight will be off when the heat pump is in sleep mode. To wake up the heat pump, simply slide a finger across the buttons.

- The display will illuminate.
- The message "KEYPAD UNLOCKED" will briefly appear.
- Then the water temperature and mode will display.

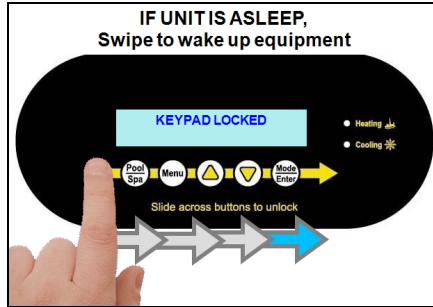

B Choose what you want the heat pump to do

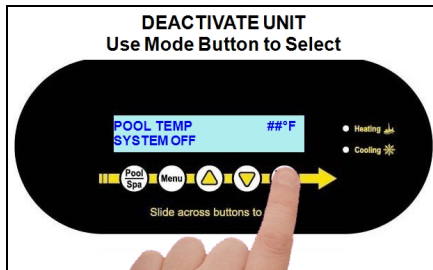
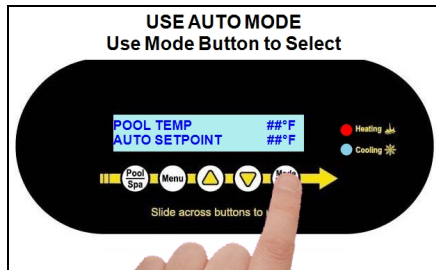
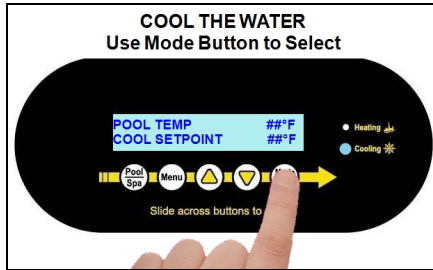
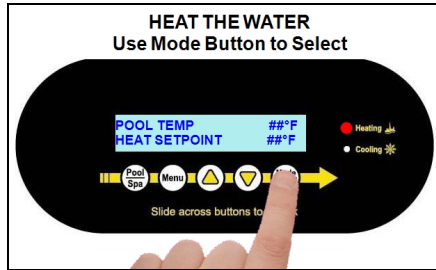

C Set a desired temperature (setpoint) for the water

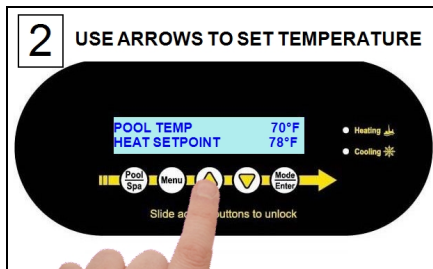
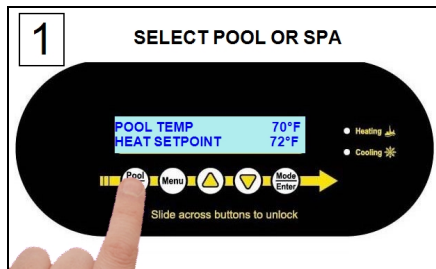

Where are the controls?

The display panel is located in a door compartment on the front of the heat pump. This compartment is designed to protect the display against harsh weather. It can also be padlocked for extra security.

- Press the **bottom** of the panel to open the display panel door.
- To close, push the display panel up. Then press the **bottom** of the panel in until a clicking noise is heard.

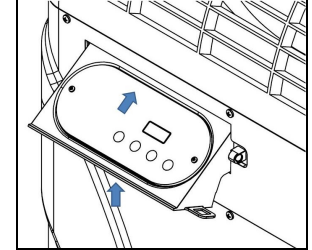
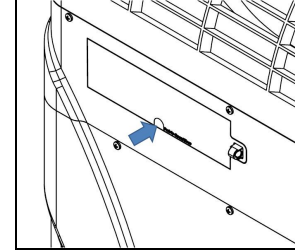

What's on the display

Buttons	Description
	Slowly slide a finger across the buttons from left to right to disable the sleep mode. Sleep mode will automatically reactivate after three minutes have passed.
	Select either the pool or the spa thermostat.
	Enter the user menu for heat pump options.
	Used to increase temperature set point and navigate through menu options.
	Used to decrease temperature set point and navigate through menu options.
	Used to select the heat pump's operating mode. Also used to edit or confirm options in a menu.

Indicators	Description
Heating	Red LED indicates the unit is heating the water.
Cooling	Blue LED indicates the unit is cooling the water.

When calling for heating or cooling, up to a three-minute delay may occur before the compressor starts. The compressor must be operating before the indicator will illuminate.

Why is my heat pump asking for an entry code?

If a user entry code has been enabled in the user menu, an entry code will be required to access heat pump options.

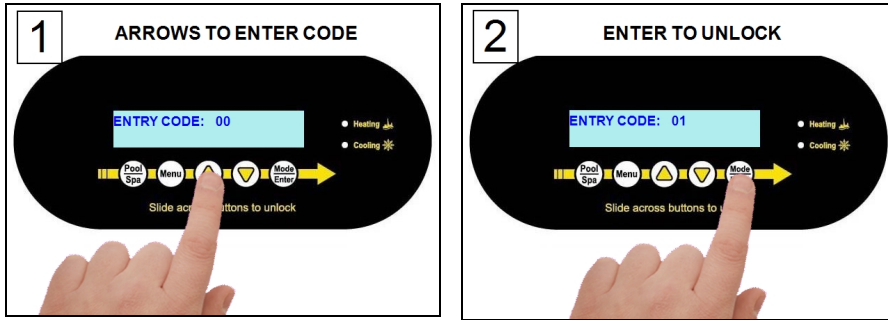

Heating the water for the first time?

1. Confirm heat pump mode has been set to heating mode.
2. Set the desired temperature (set-point) for the water.
3. Temporarily set the filter pump for continuous operation.
4. Use a pool cover or blanket to reduce heating time.

Cooling the water for the first time?

1. Confirm heat pump mode has been set to cooling mode.
2. Set thermostat to desired water temperature.
3. Temporarily set the filter pump for continuous operation.

Water under the heat pump?

Water may be seen around the heat pump. This is normal condensation produced as a byproduct of this type of system.

- The amount of condensation depends on the amount of humidity in the air. Quantities of 8 to 10 gallons (30 to 38 liters) per hour are common. Low humidity may result in no condensation.
- Keep the drain holes at the base of the unit free of grass and weeds. This will allow condensation to drain from the heat pump. If the heat pump is located under trees, leaves may fall and accumulate in the bottom of the unit. Accumulated debris should be removed by a qualified technician.

Pool Blankets

A pool blanket can assist the heater to maintain water temperature while significantly reducing heating costs. Conventional blankets, commonly referred to as "Solar Blankets", are a thin plastic-like membrane that floats on the water surface. To be effective solar blankets are physically placed over the water surface when the pool is not in use.

WARNING

Failure to heed the following may result in injury or death.

- Improperly used, Pool-Spa solar blankets can become a drowning risk to people and pets. Solar blankets are not safety covers. They are not designed to support the weight of a person or pet. Never enter a pool until the solar cover is completely removed. Under no circumstances should anyone swim under the blanket. Follow all safety recommendations of the blanket manufacturer.

Liquid Blankets

For those who want to save on heating costs, but do not want the bother and potential dangers of a conventional blanket, a liquid blanket can be a viable alternative. A liquid-blanketed pool on average loses only 30% of its heat gain overnight. However, strong winds can reduce the effectiveness of liquid blankets. Check your pool dealer / supplier for more information on pool blankets and liquid blankets.

Clearances

- Proper air circulation is required for the heat pump to operate efficiently. The following diagrams show the minimum clearances required for the proper operation of the heat pump.
- Avoid storing chemical containers near the heat pump. The chemicals can cause equipment damage.
- Avoid placing objects near or on top of the heat pump. This includes shrubbery and lawn furniture. These objects will reduce performance and efficiency and hinder maintenance access.

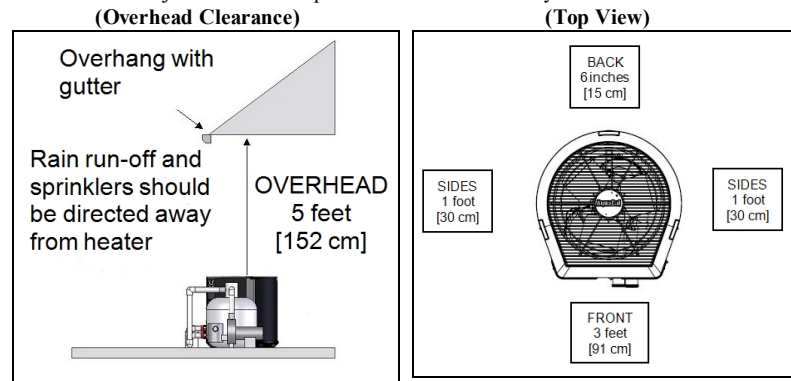

How can I find out more about my heat pump?

Please go online at www.AquaCal.com for installation, maintenance, winterization, equipment or troubleshooting advice.

Contacting AquaCal AutoPilot, Inc.

For further assistance, please contact the distributor or installer of this product.

If unavailable, please contact AquaCal® for a partner in your area. To better assist you, please have the heat pump model and serial number available.

Product Information:	
Website	www.AquaCal.com
Phone	(1) 727-823-5642
Hours	8-5 pm, Eastern M-F

Service Information:	
Website	www.AquaCal.com/request-heat-pump-service/
Phone	(1) 727-823-5642
Hours	8-5 pm, Eastern M-F